

# HDCVI

## PRODUCT CATALOG

2015 Version 2

DAHUA TECHNOLOGY  
MAKE YOUR LIFE SAFER

HDCVI Academy

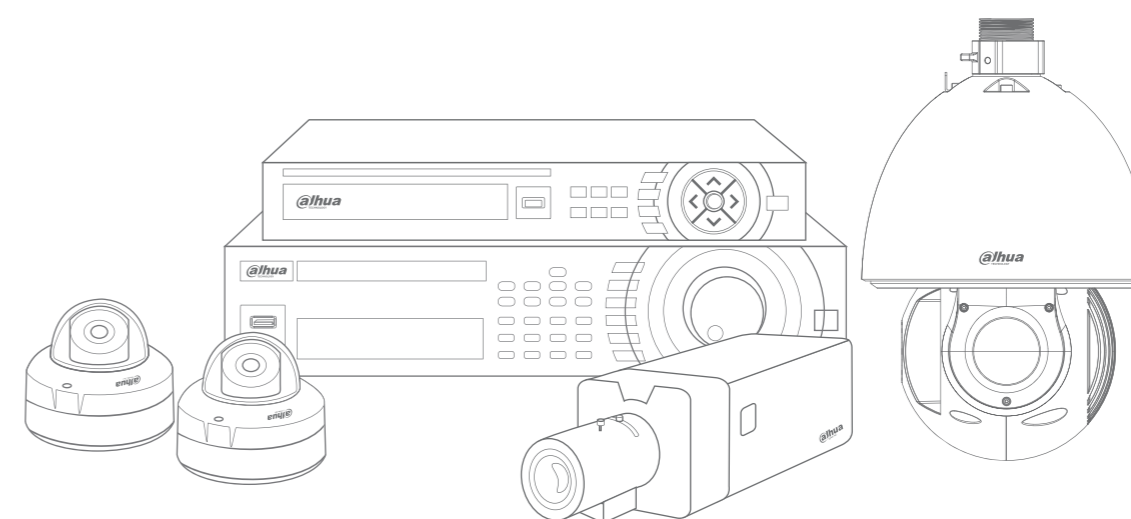

\*Design and specifications are subject to change without notice.

HDCVI - 2015 Version 2, May 2015



**DAHUA TECHNOLOGY CO., LTD.**

No.1199 Bin'an Road, Binjiang District, Hangzhou, China. 310053

Tel: +86-571-87688883 Fax: +86-571-87688815

Email: [overseas@dahuatech.com](mailto:overseas@dahuatech.com)

[www.dahuasecurity.com](http://www.dahuasecurity.com)



© Dahua Technology, All rights reserved

# Product Line-up

## HDCVI Technical

HDCVI Technical	03
HDCVI Function	05
HDCVI Case Study	07

## HDCVI DVR

### 1080P

DH-HCVR7804/7808/7816S	10
DH-HCVR7404/7408/7416L	11
DH-HCVR7204/7208A-S2	12
DH-HCVR7104/7108HE-S2	13
DH-HCVR7104/7108H-S2	14
DH-HCVR7104C-S2	15

### 720P-Pro

DH-HCVR5824/5832S-S2	16
DH-HCVR5424/5432L-S2	17
DH-HCVR5804/5808/5816S-V2	18
DH-HCVR5404/5408/5416L-V2	19
DH-HCVR5204/5208/5216A-S2	20
DH-HCVR5216AN-S2	21
DH-HCVR5104/5108/5116HE-S2	22
DH-HCVR5104/5108/5116H-S2	23
DH-HCVR5104/5108C-S2	24
DH-HCVR504	25

### 720P-Lite

DH-HCVR4224/4232L-S2	26
DH-HCVR4224/4232AN-S2	27
DH-HCVR4204/4208/4216A-S2	28
DH-HCVR4216AN-S2	29
DH-HCVR4104/4108/4116HE-S2	30
DH-HCVR4104/4108/4116HS-S2	31
DH-HCVR4104/4108C-S2	32

## iHCVR

DH-iHCVR5104/5108HE-F	33
DH-iHCVR5104/5108H-F	34

## Mobile

DH-MCVR5104	35
-------------	----

## HDCVI PTZ Camera

### 1080P

DH-HAC-HF3220E	37
DH-HAC-HFW3220E-Z(H)	38
DH-HAC-HDBW3220E-Z(H)	39
DH-HAC-HFW2220R-Z(-IRE6)	40
DH-HAC-HFW2220R-VF(-IRE6)	41
DH-HAC-HDBW2220R-Z	42
DH-HAC-HDBW2220R-VF	43
DH-HAC-HDW2220E-Z	44
DH-HAC-HDW2220R-VF	45
DH-HAC-HFW2220D-B/DH-HAC-HFW2220B-B	46
DH-HAC-HFW2220E	47
DH-HAC-HFW2220S	48
DH-HAC-HDBW2220E	49
DH-HAC-HDBW2220F	50
DH-HAC-HDW2220E	51
DH-HAC-HDW2220M	52
DH-HAC-HDW2220S	53
DH-HAC-HFW1200R-VF(-IRE6)	54
DH-HAC-HDBW1200R-VF	55
DH-HAC-HDW1200R-VF	56
DH-HAC-HFW1200B	57
DH-HAC-HFW1200S	58
DH-HAC-HFW1200RM	59
DH-HAC-HFW1200R	60

# Product Line-up

DH-HAC-HDBW1200E	61
DH-HAC-HDW1200E	62
DH-HAC-HDW1200M	63

## 720P

DH-HAC-HF3101	64
DH-HAC-HFW2120R-Z(-IRE6)	65
DH-HAC-HFW2120R-VF(-IRE6)	66
DH-HAC-HDBW2120R-Z	67
DH-HAC-HDBW2120R-VF	68
DH-HAC-HDW2120E-Z	69
DH-HAC-HDW2120R-VF	70
DH-HAC-HFW2120D-B/DH-HAC-HFW2120B-B	71
DH-HAC-HFW2120E	72
DH-HAC-HFW2120S	73
DH-HAC-HDBW2120E	74
DH-HAC-HDBW2120F	75
DH-HAC-HDW2120E	76
DH-HAC-HDW2120M	77
DH-HAC-HDW2120S	78
DH-HAC-HFW1100R-VF	79
DH-HAC-HDBW1100R-VF	80
DH-HAC-HDW1100R-VF	81
DH-HAC-HFW1100D-B/DH-HAC-HFW1100B-B	82
DH-HAC-HFW1100S	83
DH-HAC-HFW1100RM	84
DH-HAC-HFW1100R	85
DH-HAC-HDBW1100E	86
DH-HAC-HDW1100M	87
DH-HAC-HDW1100R	88
DH-HAC-HFW1000S	89
DH-HAC-HFW1000RM	90
DH-HAC-HFW1000R	91

DH-HAC-HDW1000M	92
DH-HAC-HDW1000R	93
DH-HAC-HUM3100/3101B	94

## Mobile

DH-HAC-HDBW2220F-M	95
DH-HAC-HDBW2120F-M	96

## HDCVI PTZ Camera

### 1080P

DH-SD6A220K/230K-HC	98
DH-SD6C220K/230K-HC	99
DH-SD59212K/220K/230K-HC	100
DH-SD50(52C)220K/230K-HC	101
DH-SD40/42/42C212K-HC	102
DH-SD22204K-GC	103

### 720P

DH-SD6A120K-HC	104
DH-SD6C120K-HC	105
DH-SD59112K/120K-HC	106
DH-SD50/52C120K-HC	107
DH-SD40/42/42C112K-HC	108



## Overview

Dahua Technology releases High Definition Composite Video Interface (HDCVI) technology of Independent Intellectual Property Rights. HDCVI is a video transmission technology in high definition via coaxial cable, allowing reliable long-distance HD transmission at lower cost, while complex deployment is applicable.

HDCVI modulates video signal to level and then transmit by adopting base-band and quadrature amplitude modulation; which is also the reason of its naming. This technology avoids the cross talk of CVBS and completely separates the brightness signal and hue signal, hence further enhances video quality.

HDCVI offers two specifications — 1920H (1920×1080) and 1280H (1280×720); which are compatible with the industrial standard 1080p (1920×1080) and 720p (1280×720). In addition, the technology features a patent named auto signal compensation (ASC), which only allows an extremely low signal distortion along long-distance transmission.

HDCVI solution incorporates both cameras and DVRs, and the system is star topology structured; DVR is served as a node to have an over coax P2P (Point-to-Point) transmission to camera. Cable selection is based on transmission distance: cable 75-3 and 75-5 are recommended for transmission within 500 meters, cable 75-5 and above for over 500 meters. Connector or jointing technology could be applied for connecting and the installation is exactly the same as that of conventional analog devices, which posts no special requirements either for indoor or outdoor scenarios with better anti-interference capability offered.

To further realize multiple-signal transmission over one cable, both audio signal and dual-way data communication signal are embedded in a blanking zone; which enhances the synchronization with video signal; and max supports 44.1kHz sampling rate thanks to ASC.

The forward and reverse data channels composite in the frame blanking zone, realizing a two-way end-to-end transmission to support control commands such as camera focus, PTZ control, real-time alarm and etc. The forward outputting data supports high transmission baud rate as the sending time and electric signal baud rate are predictable, meanwhile, the receiving end is of high ASC performance; on the other hand, the reverse outputting data supports lower baud rate due to its low signal frequency and limited data, which is effected by the impedance matching. However, with ASC adopted, the reverse channel could restore electric signal during long-distance transmission at some degree.

Therefore, HDCVI is an optimal solution for megapixel high definition application, featuring non-latent long-distance transmission at lower cost.

## HDCVI Chip

Dahua HDCVI chip comprises transmitting chip (TX) and receiving chip (RX), which are designed for front-end HDCVI cameras and DVRs, respectively; Chips could also be applied in fiber optic transceiver, distributor, matrix as well.

## Transmitting Chip (TX)

TX interfaces includes BT1120/BT656 digital video interface, I2S audio interface and I2C configuration interface, which are all of industrial standard design, allowing TX chip to use any standard interface for ISPs and audio chips on the market.

As for analog output, in addition to HDCVI format, the TX chip is also compatible with CVBS. The TX chip supports 1280H@25fps/30fps/50fps/60fps and 1920H@25fps/30fps.

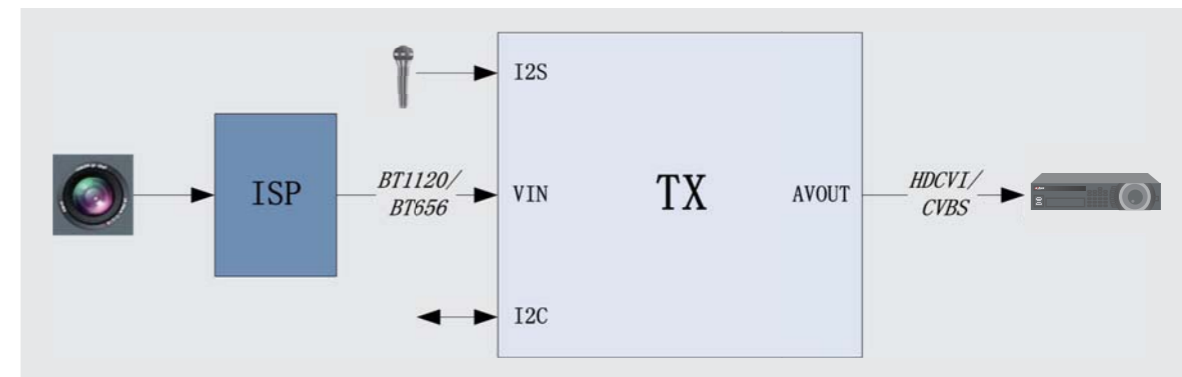

Figure 1 TX Flow Chart

The figure above shows the simplicity of HDCVI solution with TX chip adopted; its tiny size of the chip also makes itself quite suitable for the application in all kinds of camera sizes.

## Receiving Chip (RX)

The RX chip supports HDCVI HD inputs and digital video outputs; I2S audio output, multiple-chip audio cascade output as well as I2C configuration interface; it also supports flexible mapping of HDCVI video input channel and digital output channel; each channel is of its own format and built-in equalizer, supporting video parameters setup such as brightness, contrast, hue, saturation, dual-way control signal transmission.

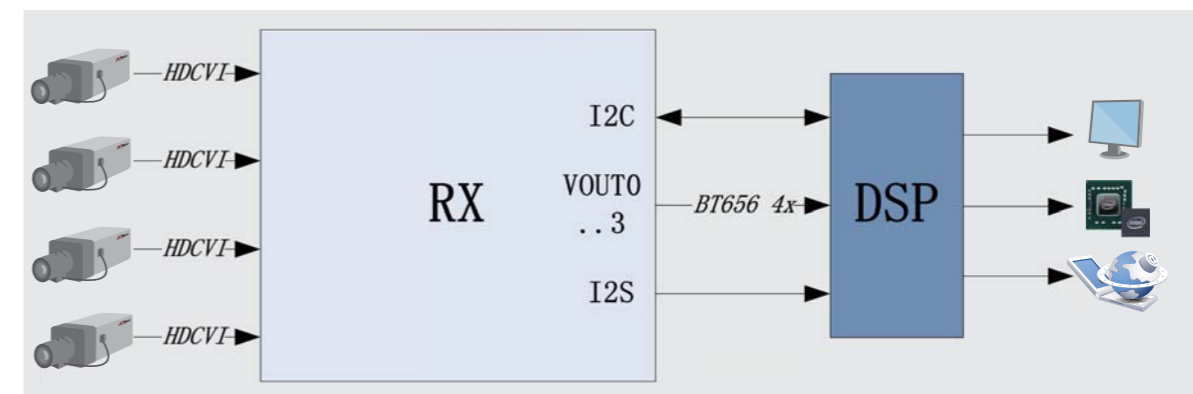

Figure 2 RX Flow Chart

As seen in Figure 2, RX chip has the same interface as AD chip in a conventional analog DVR, which is to say that it provides seamless integration with conventional DVRs; and the built-in equalizer allows HDCVI DVR to receive HD video signal up to 500 meters. The TX chip supports 1280H@25fps/30fps/50fps/60fps and 1920H@25fps/30fps.

In a word, with minor changes done on conventional cameras and DVRs shall the manufacturers embrace a brand-new HDCVI solution, which levels up image quality dramatically, but at a lower cost.

# HDCVI Function

## HDCVI VS. HD-SDI

### Longer Transmission Distance

Both HDCVI and HD-SDI can transfer HD signal @720p/1080p, but HDCVI has a distinguished advantage at the transmission distance. With general transmission media, HD-SDI reaches 100 meters at most while HDCVI, at least, transmits 500 meters by using 75-3 cable and featuring low signal distortion rate.

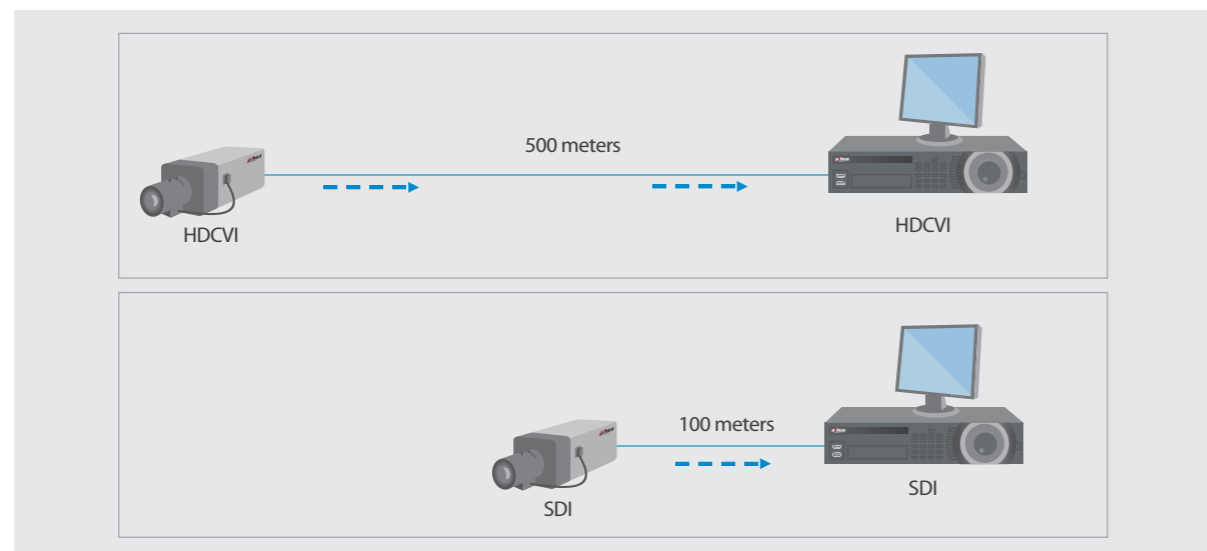

Figure 3 Contrast on Transmission Distance

### Better Anti-Interference Capability

The anti-interference capability of HD-SDI solution is relatively poor when been placed against high-frequent radiation environment, which could lead to higher bit error ratio while the HDCVI adopts low-frequency modulation technology, making it free from the high-frequency wireless electric radiation to ensure stable video transmission at high image quality.

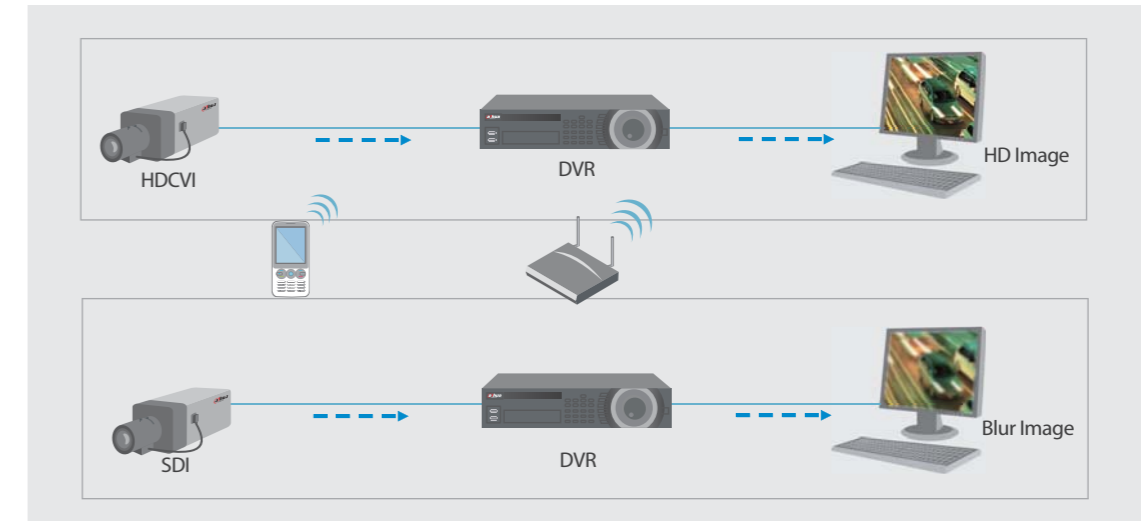

Figure 4 Anti-Interference Capability

## HDCVI VS. IP

### Reliability

HDCVI adopts P2P transmission to ensure a smooth and reliable transmission; while the transmission of network camera is based on Ethernet and thus may lead to network jitter and packet loss.

### Real-time

The network HD features video buffer technology and the delay is controlled within 300 milliseconds in the general and fair networking environment; However, HDCVI features no latency capability for an outstanding real-time performance.

### No Compression

For HDCVI, there is no compression processed to maintain its original effect and thus present in vivid image quality.

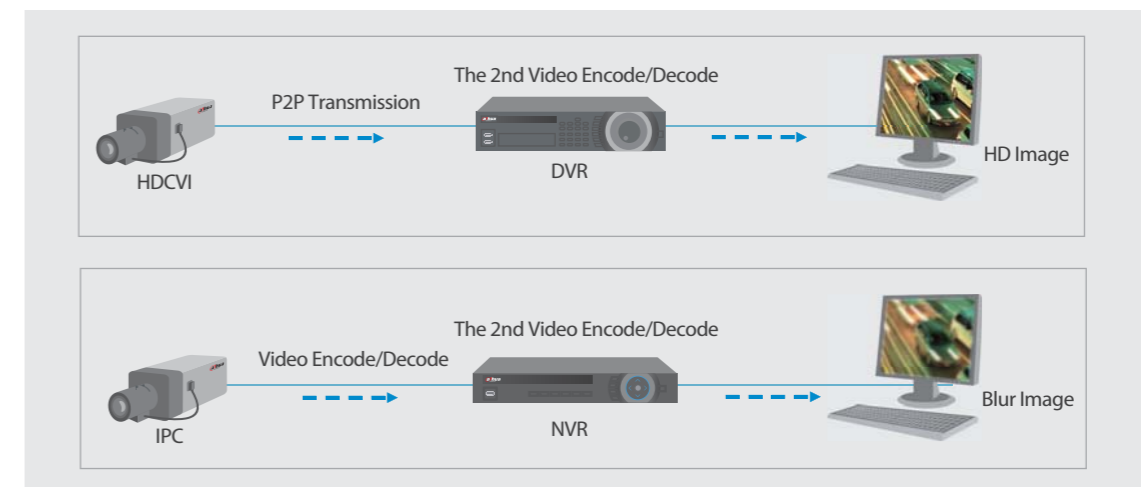

Figure 5

## Highlights

### Lower Cost

Unlike HD-SDI, which posts high demands on cabling and installation; HDCVI solution inherits the same installing means of conventional analog solutions, which is of great convenience and also decrease the cost.

### Smart control

As HDCVI transmits multiple-signal (video/audio and dual-way data) over one cable, it realizes video/audio synchronized transmission and reverse-signal transmission control at the same time, such as PTZ and zoom control; which further simplifies the installation.

# HDCVI Case Study

## Dahua HDCVI Secures CICA Shanghai

Dahua Technology, a world-leading manufacturer and supplier of video surveillance products headquartered in Hangzhou, China successfully secured five-rated hotels in Shanghai with in-house HDCVI solution. These hotels were playing host to 46 national and organization leaders in Asia during the fourth summit of Conference on Interaction and Confidence-Building Measures (CICA).



CICA Shanghai was hosted during 20th to 21st of May and the conference plays a significant role in security cooperation through out Asia, Xi Jinping, President of People's Republic of China also attended and presided over the summit.

Shanghai municipal government attached great importance to the summit and spared no endeavor to make sure everything goes secured. To level up video surveillance is among on its must-do list. More than 50 reception hotels are required to upgrade surveillance system from standard definition to high definition. And the biggest challenge is under great pressure by time frame, how to make sure the image quality and product replacement would not compromise the daily reception and security concern of these five-star rated hotels.

Under such circumstance and given the fact that these hotels were dominated by conventional analog systems, it came to a natural decision to adopt Dahua HDCVI as it allows easy upgrade without changing the existing cabling while also provides long-distance and non-latent image quality. Moreover, the whole upgrade takes more or less 10 days to as cabling are remained, only cameras, DVRs along with fiber optical transceivers are replaced by HDCVI ones.



With aesthetic requirement for the hotels, HDCVI offers wide range of housings and its speed domes and box cameras are perfectly coexisting with the décor in the lobby, reception, entrance and dining areas.

"This project demonstrates all the benefits of HDCVI and has proved applicable and workable," said Tim Shen, Overseas Marketing Director at Dahua Technology. "Within only 10 days, the whole video surveillance system has been upgraded to high definition which is not likely happened to IP solution. What HDCVI has been offered to the industry is another HD solution and this is highly gratified by our customers while cabling, cost and IP hassles are the concerned issues."



# HDCVI DVR

## DH-HCVR7804/7808/7816S

### 4/8/16CH Tribrid 1080P 2U HDCVI DVR

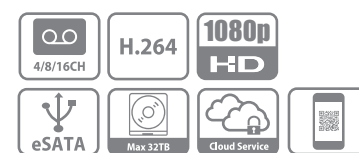

#### Features

- Tribrid: Each channel supports HDCVI/Analog/IP Video input
- 1HDMI/VGA/TV simultaneous video output, 1 HDMI separate output
- HCVR7804/7808/7816S: All channel 1080P realtime recording
- H.264 dual-stream video compression
- 4/8 channel synchronous realtime playback, GRID interface & smart search
- Support Multi-brand network cameras: Dahua, Arecont Vision, AXIS, Bosch, Brickcom, Canon, CP Plus, Dynacolor, Honeywell, Panasonic, Pelco, Samsung, Sanyo, Sony, Videosec, Vivotek and etc.
- ONVIF Version 2.4 conformance
- 3D intelligent positioning with Dahua PTZ camera
- Support 8 SATA HDDs up to 32TB, 1 eSATA, 4 USB2.0
- Multiple network monitoring: Web viewer, CMS(DSS/Smart PSS)&Smart Phone(DMSS)

#### System Connection

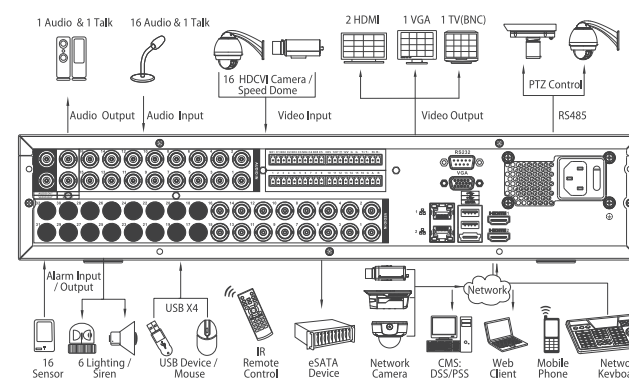

\* Takes HCVR7816S as an example

#### Technical Specifications

Model	DH-HCVR7804S	DH-HCVR7808S	DH-HCVR7816S
<b>System</b>			
Main Processor	Embedded processor		
Operating System	Embedded LINUX		
<b>Video</b>			
Input	4 channel	8 channel	16 channel
Video Standard	HDCVI	1080P/720P HDCVI Camera	
	Analog	NTSC/PAL	
	IP	All channels support 1080P/720P IP Camera	
<b>Audio</b>			
Input	4 channel, BNC	8 channel, BNC	16 channel, BNC
Output	1 channel, BNC		
Two-way Talk	1 channel input, 1 channel output, BNC		
<b>Display</b>			
Interface	2 HDMI, 1 VGA, 1 TV		
Resolution	1920×1080, 1280×1024, 1280×720, 1024×768		
Display Split	1/4	1/4/8/9	1/4/8/9/16
Privacy Masking	4 rectangular zones (each camera)		
OSD	Camera title, Time, Video loss, Camera lock, Motion detection, Recording		
<b>Recording</b>			
Video/Audio Compression	H.264/G.711		
Record Rate	Main stream	1080P/720P/960H/D1/HD1/2CIF/CIF(1~25/30fps)	
	Extra stream	CIF/QCIF(1~25/30fps)	
Bit Rate	48~6144Kb/s		
Recording Mode	Manual, Schedule(Regular(Continuous), MD, Alarm), Stop		
Recording Interval	1~60 min (default: 60 min), Pre-record: 1~30 sec, Post-record: 10~300 sec		
<b>Video Detection &amp; Alarm</b>			
Trigger Events	Recording, PTZ, Tour, Alarm out, Video Push, Email, FTP, Snapshot, Buzzer & Screen tips		
Motion Detection	Motion Detection, MD Zones: 396(22×18), Video Loss & Camera Blank		
Alarm Input	4 channel	8 channel	16 channel
Relay Output	6 channel		
<b>Playback &amp; Backup</b>			
Sync Playback	1/4	1/4/9	1/4/9/16
Search Mode	Time/Date, Alarm, MD & Exact search (accurate to second), Smart search		
Playback Functions	Play, Pause, Stop, Rewind, Fast play, Slow play, Next file, Previous file, Next camera, Previous camera, Full screen, Repeat, Shuffle, Backup selection, Digital zoom		
Backup Mode	USB Device/eSATA Device/Internal SATA burner/Network		
<b>Network</b>			
Ethernet	2RJ-45 port (10/100M/1000M)		
Network Functions	HTTP, IPv4/IPv6, TCP/IP, UPNP, RTSP, UDP, SMTP, NTP, DHCP, DNS, PPPoE, DDNS, FTP, IP Filter, Alarm Server, SNMP, P2P		
Max. User Access	128 users		
Smart Phone	iPhone, iPad, Android, Windows Phone		
<b>Storage</b>			
Internal HDD	8 SATA ports(8HDDs or 6HDDs+1CD/DVD-RW), up to 32TB		
External HDD	1 eSATA port		
<b>Auxiliary Interface</b>			
USB	4 ports(2 Rear), USB2.0		
RS232	1 port, For PC communication & Keyboard		
RS485	1 port RS485 for PTZ control		
<b>General</b>			
Power Supply	AC 100~240 V, 50/60 Hz		
Power Consumption	40W(without HDD)		
Working Environment	-10°C~+55°C/10%~90%RH/86~106kpa		
Dimension(W×D×H)	2U, 440mm×460mm×89mm		
Weight	6.5kg (without HDD)		

HDCVI DVR

HDCVI Camera

HDCVI PTZ Camera

# DH-HCVR7404/7408/7416L



4/8/16CH Tribrid 1080P 1.5U HDCVI DVR

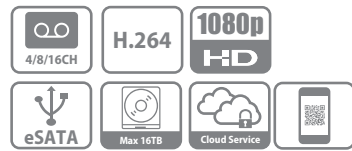

## Features

- Tribrid: Each channel supports HDCVI/Analog/IP Video input
- 1HDMI/VGA/TV simultaneous video output, 1 HDMI separate output
- HCVR7404/7408/7416L: All channel 1080P realtime recording
- H.264 dual-stream video compression
- 4/8 channel synchronous realtime playback, GRID interface & smart search
- Support Multi-brand network cameras: Dahua, Arecont Vision, AXIS, Bosch, Brickcom, Canon, CP Plus, Dynacolor, Honeywell, Panasonic, Pelco, Samsung, Sanyo, Sony, Videosec, Vivotek and etc.
- ONVIF Version 2.4 conformance
- 3D intelligent positioning with Dahua PTZ dome camera
- Support 4 SATA HDDs up to 16TB, 1 eSATA, 3 USB2.0
- Multiple network monitoring: Web viewer, CMS(DSS/Smart PSS)&Smart Phone(DMSS)

## System Connection

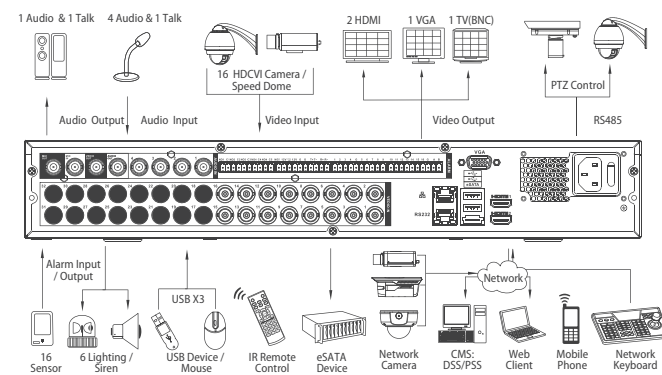

\* Takes HCVR7416L as an example

## Technical Specifications

Model	DH-HCVR7404L	DH-HCVR7408L	DH-HCVR7416L
<b>System</b>			
Main Processor	Embedded processor		
Operating System	Embedded LINUX		
<b>Video</b>			
Input	4 channel	8 channel	16 channel
Video Standard	HDCVI	1080P/720P HDCVI Camera	
	Analog	NTSC/PAL	
	IP	All channels support 1080P/720P IP Camera	
<b>Audio</b>			
Input	4 channel, BNC		
Output	1 channel, BNC		
Two-way Talk	1 channel input, 1 channel output, BNC		
<b>Display</b>			
Interface	2 HDMI, 1 VGA, 1 TV		
Resolution	1920×1080, 1280×1024, 1280×720, 1024×768		
Display Split	1/4	1/4/8/9	1/4/8/9/16
Privacy Masking	4 rectangular zones (each camera)		
OSD	Camera title, Time, Video loss, Camera lock, Motion detection, Recording		
<b>Recording</b>			
Video/Audio Compression	H.264/G.711		
Resolution	1080P(1920×1080)/720P(1280×720)/960H(960×576/960×480)/D1/4CIF(704×576/704×480)/CIF(352×288/352×240)/QCIF(176×144/176×120)		
Record Rate	Main stream	1080P/720P/960H/D1/HD1/2CIF/CIF(1~25/30fps)	
	Extra stream	CIF/QCIF(1~25/30fps)	
Bit Rate	48~61.44Kb/s		
Record Mode	Manual, Schedule(Regular/Continuous), MD, Stop		
Record Interval	1~60 min (default: 60 min), Pre-record: 1~30 sec, Post-record: 10~300 sec		
<b>Video Detection &amp; Alarm</b>			
Trigger Event	Recording, PTZ, Tour, Alarm out, Video Push, Email, FTP, Spot, Snapshot, Buzzer & Screen tips		
Video Detection	Motion Detection, MD Zones: 396(22×18), Video Loss & Camera Blank		
Alarm Input	4 channel	8 channel	16 channel
Relay Output	6 channel		
<b>Playback &amp; Backup</b>			
Sync Playback	1/4	1/4/9	1/4/9/16
Search Mode	Time/Date, MD & Exact search (accurate to second)		
Playback Functions	Play, Pause, Stop, Rewind, Fast play, Slow play, Next file, Previous file, Next camera, Previous camera, Full screen, Repeat, Shuffle, Backup selection, Digital zoom		
Backup Mode	USB Device/eSATA Device/Internal SATA burner/Network		
<b>Network</b>			
Ethernet	RJ-45 port (10/100M/1000M)		
Network Functions	HTTP, IPv4/IPv6, TCP/IP, UPNP, RTSP, UDP, SMTP, NTP, DHCP, DNS, PPPOE, DDNS, FTP, IP Filter, SNMP, P2P		
Max. User Access	128 users		
Smart Phone	iPhone, iPad, Android, Windows Phone		
<b>Storage</b>			
Internal HDD	4 SATA ports(4 HDDs or 3HDDs+1 CD/DVD-RW), up to 16TB, Raid(redundancy)		
External HDD	1 eSATA port		
<b>Auxiliary Interface</b>			
USB Interface	3 ports(2 Rear), USB2.0		
RS232	1 port, For PC communication & Keyboard		
RS485	1 port RS485 for PTZ control, 1 port RS422 for Keyboard		
<b>General</b>			
Power Supply	AC 100~240 V, 50/60 Hz		
Power Consumption	40W(without HDD)		
Working Environment	-10°C ~+55°C / 10%~90%RH / 86~106kpa		
Dimension(W×D×H)	1.5U, 440mm×416mm×68mm		
Weight	6kg (without HDD)		

# DH-HCVR7204/7208A-S2 NEW



4/8CH Tribrid 1080P 1U HDCVI DVR



## Features

- Support HDCVI/Analog/IP Video input
- H.264 dual-stream video compression
- HCVR7204/7208A-S2: All channel 1080P realtime recording
- 4/8 channel synchronous realtime playback, GRID interface & smart search
- HDMI/VGA simultaneous video output
- Support 2 SATA HDDs up to 8TB, 2 USB2.0
- Support Multi-brand network cameras: Dahua, Arecont Vision, AXIS, Bosch, Brickcom, Canon, CP Plus, Dynacolor, Honeywell, Panasonic, Pelco, Samsung, Sanyo, Sony, Videosec, Vivotek and etc.
- ONVIF Version 2.4 conformance
- 3D intelligent positioning with Dahua PTZ dome camera
- Multiple network monitoring: Web viewer, CMS(DSS/Smart PSS)&Smart Phone(DMSS)

## System Connection

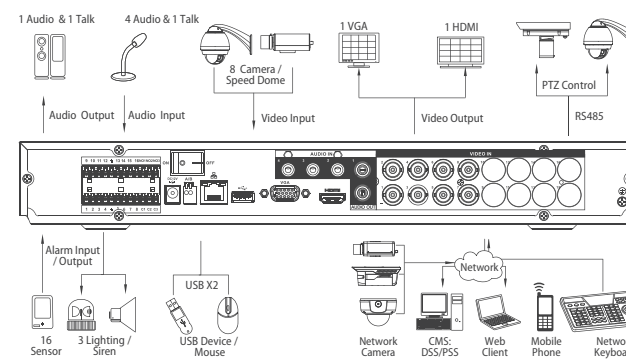

\* Takes HCVR7208A-S2 as an example

## Technical Specifications

Model	DH-HCVR7204A-S2	DH-HCVR7208A-S2
<b>System</b>		
Main Processor	Embedded processor	
Operating System	Embedded LINUX	
<b>Video</b>		
Input	4 channel, BNC	8 channel, BNC
Video Standard	HDCVI	1080P/720P HDCVI Camera
	Analog	NTSC/PAL
	IP	Support 2ch 1080P/720P IP Camera
<b>Audio</b>		
Input	4 channel, RCA	
Output	1 channel, RCA	
Two-way Talk	Reuse audio input/output channel 1	
<b>Display</b>		
Interface	1 HDMI, 1 VGA	
Resolution	1920×1080, 1280×1024, 1280×720, 1024×768	
Display Split	1/4	1/4/8/9
Privacy Masking	4 rectangular zones (each camera)	
OSD	Camera title, Time, Video loss, Camera lock, Motion detection, Recording	
<b>Recording</b>		
Video/Audio Compression	H.264/G.711	
Record Rate	Main stream	1080P/720P/960H/D1(1~25/30fps)
	Extra stream	CIF/QCIF(1~25/30fps), D1
Bit Rate	96~61.44Kb/s	
Record Mode	Manual, Schedule(Regular/Continuous), MD, Stop	
Record Interval	1~60 min (default: 60 min), Pre-record: 1~30 sec, Post-record: 10~300 sec	
<b>Video Detection &amp; Alarm</b>		
Trigger Event	Recording, PTZ, Tour, Alarm out, Video Push, Email, FTP, Snapshot, Buzzer & Screen tips	
Video Detection	Motion Detection, MD Zones: 396(22×18), Video Loss & Camera Blank	
Alarm Input	8 channel	16 channel
Relay Output	3 channel	
<b>Playback &amp; Backup</b>		
Sync Playback	1/4	1/4/9
Search Mode	Time/Date, MD & Exact search (accurate to second)	
Playback Functions	Play, Pause, Stop, Rewind, Fast play, Slow play, Next file, Previous file, Next camera, Previous camera, Full screen, Repeat, Shuffle, Backup selection, Digital zoom	
Backup Mode	USB Device/Internal SATA burner/Network	
<b>Network</b>		
Ethernet	RJ-45 port (10/100M)	RJ-45 port (10/100M/1000M)
Network Functions	HTTP, IPv4/IPv6, TCP/IP, UPNP, RTSP, UDP, SMTP, NTP, DHCP, DNS, PPPOE, DDNS, FTP, IP Filter, SNMP, P2P	
Max. User Access	128 users	
Smart Phone	iPhone, iPad, Android, Windows Phone	
<b>Storage</b>		
Internal HDD	2 SATA ports, up to 8TB	
<b>Auxiliary Interface</b>		
USB Interface	2 ports(1 Rear), USB2.0	
RS485	1 port, For PTZ control	
<b>General</b>		
Power Supply	DC12V/4A	DC12V/5A
Power Consumption	15W(without HDD)	
Working Environment	-10°C ~+55°C / 10%~90%RH / 86~106kpa	
Dimension(W×D×H)	1U, 375mm×285mm×55mm	
Weight	2.35kg (without HDD)	

HDCVI DVR  
HDCVI Camera  
HDCVI PTZ Camera

# DH-HCVR7104/7108HE-S2 **NEW**



4/8CH Tribrid 1080P Mini 1U HDCVI DVR



## Features

- Support HDCVI/Analog/IP Video input
- H.264 dual-stream video compression
- HCVR7104/7108HE-S2: All channel 1080P realtime recording
- HDMI/VGA simultaneous video output
- 4/8 channel synchronous realtime playback, GRID interface & smart search
- Support Multi-brand network cameras: Dahua, Arecont Vision, AXIS, Bosch, Brickcom, Canon, CP Plus, Dynacolor, Honeywell, Panasonic, Pelco, Samsung, Sanyo, Sony, Videosec, Vivotek and etc.
- ONVIF Version 2.4 conformance
- 3D intelligent positioning with Dahua PTZ dome camera
- Support 1 SATA HDD up to 4TB, 2 USB2.0
- Multiple network monitoring: Web viewer, CMS(DSS/Smart PSS)&Smart Phone(DMSS)

## System Connection

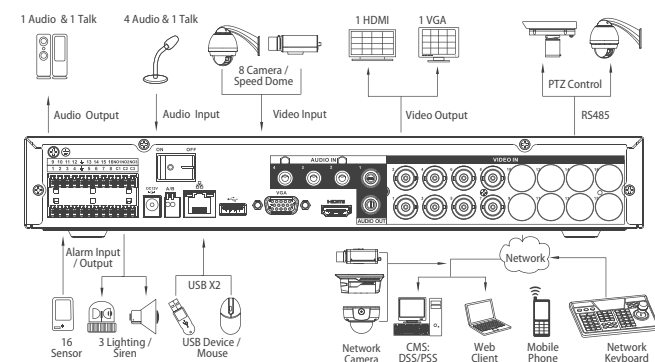

\* Takes HCVR7108HE-S2 as an example

## Technical Specifications

Model	DH-HCVR7104HE-S2	DH-HCVR7108HE-S2
<b>System</b>		
Main Processor	Embedded processor	
Operating System	Embedded LINUX	
<b>Video</b>		
Input	4 channel, BNC	8 channel, BNC
Standard	Analog	NTSC/PAL
	HDCVI	1080P/720P HDCVI Camera
	IP	Support 2ch 1080P/720P IP Camera
<b>Audio</b>		
Input	4 channel, RCA	
Output	1 channel, RCA	
Two-way Talk	Reuse audio input/output channel 1	
<b>Display</b>		
Interface	1 HDMI, 1 VGA	
Resolution	1920×1080, 1280×1024, 1280×720, 1024×768	
Display Split	1/4	1/4/8/9
Privacy Masking	4 rectangular zones (each camera)	
OSD	Camera title, Time, Video loss, Camera lock, Motion detection, Recording	
<b>Recording</b>		
Video/Audio Compression	H.264/G.711	
Record Rate	Main stream	1080P/720P/960H/D1(1~25/30fps)
	Extra stream	CIF/QCIF(1~25/30fps), D1
Bit Rate	96~6144Kb/s	
Record Mode	Manual, Schedule(Regular/Continuous), MD, Stop	
Record Interval	1~60 min (default: 60 min), Pre-record: 1~30 sec, Post-record: 10~300 sec	
<b>Video Detection &amp; Alarm</b>		
Trigger Events	Recording, PTZ, Tour, Alarm out, Video Push, Email, FTP, Snapshot, Buzzer & Screen tips	
Video Detection	Motion Detection, MD Zones: 396(22×18), Video Loss & Camera Blank	
Alarm Input	8 channel	16 channel
Relay Output	3 channel	
<b>Playback &amp; Backup</b>		
Sync Playback	1/4	1/4/9
Search Mode	Time/Date, MD & Exact search (accurate to second)	
Playback Functions	Play, Pause, Stop, Rewind, Fast play, Slow play, Next file, Previous file, Next camera, Previous camera, Full screen, Repeat, Shuffle, Backup selection, Digital zoom	
Backup Mode	USB Device/Internal SATA burner/Network	
<b>Network</b>		
Ethernet	RJ-45 port (10/100M)	RJ-45 port (10/100M/1000M)
Network Functions	HTTP, IPv4/IPv6, TCP/IP, UPNP, RTSP, UDP, SMTP, NTP, DHCP, DNS, PPPoE, DDNS, FTP, IP Filter, SNMP, P2P	
Max. User Access	128 users	
Smart Phone	iPhone, iPad, Android, Windows Phone	
<b>Storage</b>		
Internal HDD	1 SATA port, up to 4TB	
<b>Auxiliary Interface</b>		
USB Interface	2 ports(1 Rear), USB2.0	
RS485	1 port, For PTZ Control	
<b>General</b>		
Power Supply	DC12V/2A	DC12V/3A
Power Consumption	10W(without HDD)	
Working Environment	-10°C ~ +55°C / 10%~90%RH / 86~106kpa	
Dimension(W×D×H)	Mini 1U, 325mm×255mm×55mm	
Weight	1.5kg (without HDD)	

# DH-HCVR7104/7108H-S2 **NEW**



4/8CH Tribrid 1080P Mini 1U HDCVI DVR



## Features

- Support HDCVI/Analog/IP Video input
- H.264 dual-stream video compression
- HCVR7104/7108H-S2: All channel 1080P realtime recording
- HDMI/VGA simultaneous video output
- 4/8 channel synchronous realtime playback, GRID interface & smart search
- Support Multi-brand network cameras: Dahua, Arecont Vision, AXIS, Bosch, Brickcom, Canon, CP Plus, Dynacolor, Honeywell, Panasonic, Pelco, Samsung, Sanyo, Sony, Videosec, Vivotek and etc.
- ONVIF Version 2.4 conformance
- 3D intelligent positioning with Dahua PTZ dome camera
- Support 1 SATA HDD up to 4TB, 2 USB2.0
- Multiple network monitoring: Web viewer, CMS(DSS/Smart PSS)&Smart Phone(DMSS)

## System Connection

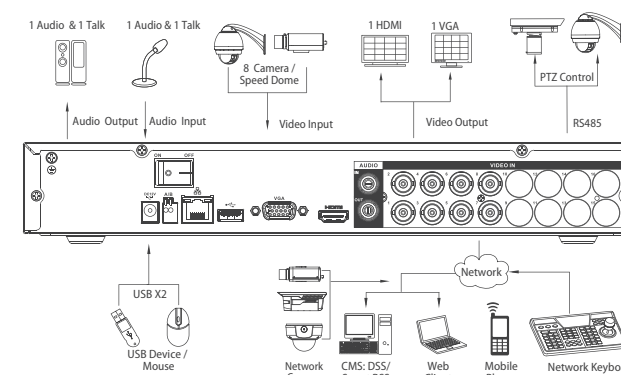

\* Takes HCVR7108H-S2 as an example

## Technical Specifications

Model	DH-HCVR7104H-V2	DH-HCVR7108H-V2
<b>System</b>		
Main Processor	Embedded processor	
Operating System	Embedded LINUX	
<b>Video</b>		
Input	4 channel, BNC	8 channel, BNC
Standard	Analog	NTSC/PAL
	HDCVI	1080P/720P HDCVI Camera
	IP	Support 2ch 1080P/720P IP Camera
<b>Audio</b>		
Input	1 channel, RCA	
Output	1 channel, RCA	
Two-way Talk	Reuse audio input/output channel 1	
<b>Display</b>		
Interface	1 HDMI, 1 VGA	
Resolution	1920×1080, 1280×1024, 1280×720, 1024×768	
Display Split	1/4	1/4/8/9
Privacy Masking	4 rectangular zones (each camera)	
OSD	Camera title, Time, Video loss, Camera lock, Motion detection, Recording	
<b>Recording</b>		
Video/Audio Compression	H.264/G.711	
Record Rate	Main stream	1080P/720P/960H/D1(1~25/30fps)
	Extra stream	CIF/QCIF(1~25/30fps), D1
Bit Rate	96~6144Kb/s	
Record Mode	Manual, Schedule(Regular/Continuous), MD, Stop	
Record Interval	1~60 min (default: 60 min), Pre-record: 1~30 sec, Post-record: 10~300 sec	
<b>Video Detection</b>		
Trigger Events	Recording, PTZ, Tour, Alarm out, Video Push, Email, FTP, Snapshot, Buzzer & Screen tips	
Video Detection	Motion Detection, MD Zones: 396(22×18), Video Loss & Camera Blank	
<b>Playback &amp; Backup</b>		
Sync Playback	1/4	1/4/9
Search Mode	Time/Date, MD & Exact search (accurate to second)	
Playback Functions	Play, Pause, Stop, Rewind, Fast play, Slow play, Next file, Previous file, Next camera, Previous camera, Full screen, Repeat, Shuffle, Backup selection, Digital zoom	
Backup Mode	USB Device/Internal SATA burner/Network	
<b>Network</b>		
Ethernet	RJ-45 port (10/100M)	RJ-45 port (10/100M/1000M)
Network Functions	HTTP, IPv4/IPv6, TCP/IP, UPNP, RTSP, UDP, SMTP, NTP, DHCP, DNS, PPPoE, DDNS, FTP, IP Filter, SNMP, P2P	
Max. User Access	128 users	
Smart Phone	iPhone, iPad, Android, Windows Phone	
<b>Storage</b>		
Internal HDD	1 SATA port, up to 4TB	
<b>Auxiliary Interface</b>		
USB Interface	2 ports(1 Rear), USB2.0	
RS485	1 port, For PTZ Control	
<b>General</b>		
Power Supply	DC12V/2A	DC12V/3A
Power Consumption	10W(without HDD)	
Working Environment	-10°C ~ +55°C / 10%~90%RH / 86~106kpa	
Dimension(W×D×H)	Mini 1U, 325mm×255mm×55mm	
Weight	1.5kg (without HDD)	

HDCVI DVR

HDCVI Camera

HDCVI PTZ Camera



# DH-HCVR7104C-S2 NEW



## 4CH Tribrid 1080P Smart 1U HDCVI DVR



### Features

- Support HDCVI/Analog/IP Video input
- H.264 dual-stream video compression
- HCVR7104C-S2: All channel 1080P realtime recording
- HDMI/VGA simultaneous video output
- 4 channel synchronous realtime playback, GRID interface & smart search
- Support Multi-brand network cameras: Dahua, Arecont Vision, AXIS, Bosch, Brickcom, Canon, CP Plus, Dynacolor, Honeywell, Panasonic, Pelco, Samsung, Sanyo, Sony, Videosec, Vivotek and etc.
- ONVIF Version 2.4 conformance
- 3D intelligent positioning with Dahua PTZ dome camera
- Support 1 SATA HDD up to 4TB, 2 USB2.0
- Multiple network monitoring: Web viewer, CMS(DSS/Smart PSS)&Smart Phone(DMSS)

### System Connection

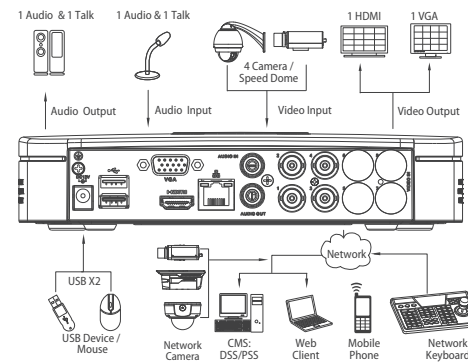

\*Takes HCVR7104C-S2 as an example

### Technical Specifications

Model	DH-HCVR7104C-S2	
<b>System</b>		
Main Processor	Embedded processor	
Operating System	Embedded LINUX	
<b>Video</b>		
Input	4 channel, BNC	
Standard	Analog	NTSC/PAL
	HDCVI	1080P/720P HDCVI Camera
	IP	Support 2ch 1080P/720P IP Camera
<b>Audio</b>		
Input	1 channel, RCA	
Output	1 channel, RCA	
Two-way Talk	Reuse audio input/output channel 1	
<b>Display</b>		
Interface	1 HDMI, 1 VGA	
Resolution	1920×1080, 1280×1024, 1280×720, 1024×768	
Display Split	1/4	
Privacy Masking	4 rectangular zones (each camera)	
OSD	Camera title, Time, Video loss, Camera lock, Motion detection, Recording	
<b>Recording</b>		
Video/Audio Compression	H.264/G.711	
Record Rate	Main stream	1080P/720P/960H/D1(1~25/30fps)
	Extra stream	CIF/QCIF(1~25/30fps), D1
Bit Rate	96~614Kb/s	
Record Mode	Manual, Schedule(Regular/Continuous), MD, Stop	
Record Interval	1~60 min (default: 60 min), Pre-record: 1~30 sec, Post-record: 10~300 sec	
<b>Video Detection</b>		
Trigger Events	Recording, PTZ, Tour, Video Push, Email, FTP, Snapshot, Buzzer & Screen tips	
Video Detection	Motion Detection, MD Zones: 396(22×18), Video Loss & Camera Blank	
<b>Playback &amp; Backup</b>		
Sync Playback	1/4	
Search Mode	Time/Date, MD & Exact search (accurate to second)	
Playback Functions	Play, Pause, Stop, Rewind, Fast play, Slow play, Next file, Previous file, Next camera, Previous camera, Full screen, Repeat, Shuffle, Backup selection, Digital zoom	
Backup Mode	USB Device/Internal SATA burner/Network	
<b>Network</b>		
Ethernet	RJ-45 port (10/100M)	
Network Functions	HTTP, IPv4/IPv6, TCP/IP, UPNP, RTSP, UDP, SMTP, NTP, DHCP, DNS, PPPoE, DDNS, FTP, IP Filter, SNMP, P2P	
Max. User Access	128 users	
Smart Phone	iPhone, iPad, Android, Windows Phone	
<b>Storage</b>		
Internal HDD	1 SATA port, up to 4TB	
<b>Auxiliary Interface</b>		
USB Interface	2 ports(2 Rear), USB2.0	
<b>General</b>		
Power Supply	DC12V/2A	
Power Consumption	10W(without HDD)	
Working Environment	-10°C ~+55°C / 10%~90%RH / 86~106kpa	
Dimension(W×D×H)	Smart 1U, 205mm×205mm×40mm	
Weight	0.5kg (without HDD)	

# DH-HCVR5824/5832S-S2 NEW



## 24/32CH Tribrid 720P-Pro 2U HDCVI DVR



### Features

- Tribrid: Each channel supports HDCVI/IP Video input
- H.264 dual-stream video compression
- HCVR5824/5832S: All channel 720P realtime recording or 1080P non-realtime recording
- 2HDMI/VGA/TV simultaneous video output
- 16 channel synchronous realtime playback, GRID interface & smart search
- Support Multi-brand network cameras: Dahua, Arecont Vision, AXIS, Bosch, Brickcom, Canon, CP Plus, Dynacolor, Honeywell, Panasonic, Pelco, Samsung, Sanyo, Sony, Videosec, Vivotek and etc.
- ONVIF Version 2.4 conformance
- 3D intelligent positioning with Dahua PTZ dome camera
- Support 8 SATA HDDs up to 32TB, 1 eSATA, 4 USB2.0
- Multiple network monitoring: Web viewer, CMS(DSS/Smart PSS)&Smart Phone(DMSS)

### System Connection

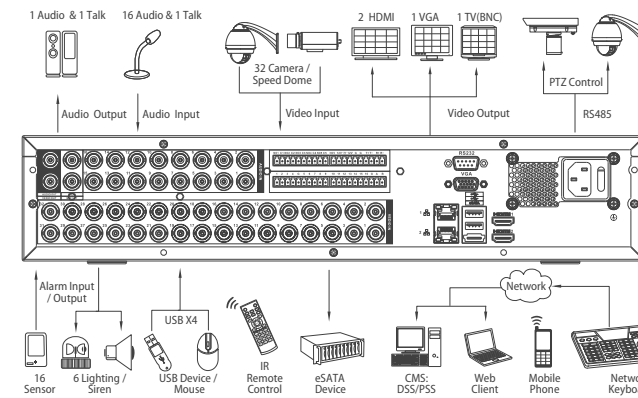

\*Takes HCVR5832S as an example

### Technical Specifications

Model	DH-HCVR5824S	DH-HCVR5832S
<b>System</b>		
Main Processor	Embedded processor	
Operating System	Embedded LINUX	
<b>Video</b>		
Input	24 channel, BNC	32 channel, BNC
Standard	HDCVI	1080P/720P HDCVI Camera
	Analog	NTSC/PAL
	IP	All channels support 1080P/720P IP Camera
<b>Audio</b>		
Input	16 channel, BNC	
Output	1 channel, BNC	
Two-way Talk	1 channel Input, 1 channel Output, BNC	
<b>Display</b>		
Interface	2 HDMI, 1 VGA, 1 TV	
Resolution	1920×1080, 1280×1024, 1280×720, 1024×768	
Display Split	1/4/8/9/16/25	1/4/8/9/16/25/36
Privacy Masking	4 rectangular zones (each camera)	
OSD	Camera title, Time, Video loss, Camera lock, Motion detection, Recording	
<b>Recording</b>		
Video/Audio Compression	H.264/G.711	
Record Rate	Main stream	1080P(1~12/15fps)/720P/960H/D1/HD1/2CIF/CIF(1~25/30fps)
	Extra stream	CIF/QCIF(1~25/30fps), D1(1~6/7fps)
Bit Rate	48~4096Kb/s	
Record Mode	Manual, Schedule(Regular/Continuous), MD, Stop	
Record Interval	1~60 min (default: 60 min), Pre-record: 1~30 sec, Post-record: 10~300 sec	
<b>Video Detection &amp; Alarm</b>		
Trigger Event	Recording, PTZ, Tour, Alarm out, Video Push, Email, FTP, Snapshot, Buzzer & Screen tips	
Video Detection	Motion Detection, MD Zones: 396(22×18), Video Loss & Camera Blank	
Alarm Input	16 channel	
Relay Output	6 channel	
<b>Playback &amp; Backup</b>		
Sync Playback	1/4/8/16	
Search Mode	Time/Date, MD & Exact search (accurate to second)	
Playback Functions	Play, Pause, Stop, Rewind, Fast play, Slow play, Next file, Previous file, Next camera, Previous camera, Full screen, Repeat, Shuffle, Backup selection, Digital zoom	
Backup Mode	USB Device/eSATA Device/Internal SATA burner/Network	
<b>Network</b>		
Ethernet	2RJ-45 port (10/100M/1000M)	
Network Functions	HTTP, IPv4/IPv6, TCP/IP, UPNP, RTSP, UDP, SMTP, NTP, DHCP, DNS, PPPoE, DDNS, FTP, IP Filter, SNMP, P2P	
Max. User Access	128 users	
Smart Phone	iPhone, iPad, Android, Windows Phone	
<b>Storage</b>		
Internal HDD	8 SATA ports(8HDDs or 6HDDs+1CD/DVD-RW), up to 32TB	
External HDD	1 eSATA port	
<b>Auxiliary Interface</b>		
USB Interface	4 ports (2 Rear), USB2.0	
RS232	1 port, For PC communication & Keyboard	
RS485	1 port RS485 for PTZ control, 1 port RS422 for Keyboard	
<b>General</b>		
Power Supply	AC 100~240 V, 50/60 Hz	
Power Consumption	40W(Without HDD)	
Working Environment	-10°C ~+55°C/10%~90%RH / 86~106kpa	
Dimension(W×D×H)	2U, 440mm×460mm×89mm	
Weight	6.5kg (without HDD)	

HDCVI DVR  
HDCVI Camera  
HDCVI PTZ Camera

# DH-HCVR5424/5432L-S2 NEW



## 24/32CH Tribrid 720P-Pro 1.5U HDCVI DVR



### Features

- Tribrid: Each channel supports HDCVI/IP Video input
- H.264 dual-stream video compression
- HCVR5424/5432L: All channel 720P realtime recording or 1080P non-realtime recording
- 2HDMI/VGA/TV simultaneous video output
- 16 channel synchronous realtime playback, GRID interface & smart search
- Support Multi-brand network cameras: Dahua, Arecont Vision, AXIS, Bosch, Brickcom, Canon, CP Plus, Dynacolor, Honeywell, Panasonic, Pelco, Samsung, Sanyo, Sony, Videosec, Vivotek and etc.
- ONVIF Version 2.4 conformance
- 3D intelligent positioning with Dahua PTZ dome camera
- Support 4 SATA HDDs up to 16TB, 1 eSATA, 3 USB2.0
- Multiple network monitoring: Web viewer, CMS(DSS/Smart PSS)&Smart Phone(DMSS)

### System Connection

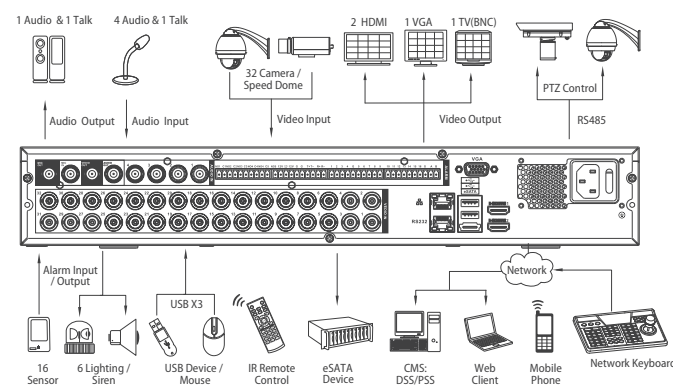

\* Takes HCVR5432L as an example

### Technical Specifications

Model	DH-HCVR5424L	DH-HCVR5432L
<b>System</b>		
Main Processor	Embedded processor	
Operating System	Embedded LINUX	
<b>Video</b>		
Input	24 channel, BNC	32 channel, BNC
Standard	HDCVI 1080P/720P HDCVI Camera Analog NTSC/PAL IP All channels support 1080P/720P IP Camera	
<b>Audio</b>		
Input	4 channel, BNC	
Output	1 channel, BNC	
Two-way Talk	1 channel Input, 1 channel Output, BNC	
<b>Display</b>		
Interface	2 HDMI, 1 VGA, 1 TV	
Resolution	1920×1080, 1280×1024, 1280×720, 1024×768	
Display Split	1/4/8/9/16/25	1/4/8/9/16/25/36
Privacy Masking	4 rectangular zones (each camera)	
OSD	Camera title, Time, Video loss, Camera lock, Motion detection, Recording	
<b>Recording</b>		
Video/Audio Compression	H.264/G.711	
Record Rate	Main stream	1080P(1~12/15fps)/720P/960H/D1/HD1/2CIF/CIF(1~25/30fps)
	Extra stream	CIF/OCIF(1~25/30fps), D1(1~6/7fps)
Bit Rate	48~4096Kb/s	
Record Mode	Manual, Schedule(Regular(Continuous), MD), Stop	
Record Interval	1~60 min (default: 60 min), Pre-record: 1~30 sec, Post-record: 10~300 sec	
<b>Video Detection &amp; Alarm</b>		
Trigger Event	Recording, PTZ, Tour, Alarm out, Video Push, Email, FTP, Snapshot, Buzzer & Screen tips	
Video Detection	Motion Detection, MD Zones: 396(22×18), Video Loss & Camera Blank	
Alarm Input	16 channel	
Relay Output	6 channel	
<b>Playback &amp; Backup</b>		
Sync Playback	1/4/9/16	
Search Mode	Time/Date, MD & Exact search (accurate to second)	
Playback Functions	Play, Pause, Stop, Rewind, Fast play, Slow play, Next file, Previous file, Next camera, Previous camera, Full screen, Repeat, Shuffle, Backup selection, Digital zoom	
Backup Mode	USB Device/eSATA Device/Internal SATA burner/Network	
<b>Network</b>		
Ethernet	RJ-45 port (10/100M/1000M)	
Network Functions	HTTP, IPv4/IPv6, TCP/IP, UPNP, RTSP, UDP, SMTP, NTP, DHCP, DNS, PPPoE, DDNS, FTP, IP Filter, SNMP, P2P	
Max. User Access	128 users	
Smart Phone	iPhone, iPad, Android, Windows Phone	
<b>Storage</b>		
Internal HDD	4 SATA ports(4 HDDs or 3HDDs+1 CD/DVD-RW), up to 16TB	
External HDD	1 eSATA port	
<b>Auxiliary Interface</b>		
USB Interface	3 ports (2 Rear), USB2.0	
RS232	1 port, For PC communication & Keyboard	
RS485	1 port RS485 for PTZ control, 1 port RS422 for Keyboard	
<b>General</b>		
Power Supply	AC 100~240 V, 50/60 Hz	
Power Consumption	40W(Without HDD)	
Working Environment	-10°C ~+55°C/10%~90%RH/86~106kpa	
Dimension(W×D×H)	1.5U, 440mm×416mm×68mm	
Weight	6kg (without HDD)	



# DH-HCVR5804/5808/5816S-V2

## 4/8/16CH Tribrid 720P-Pro 2U HDCVI DVR



### Features

- Support HDCVI/Analog/IP Video input
- H.264 dual-stream video compression
- HCVR5804/5808/5816S-V2: All channel 720P realtime or 1080P non-realtime recording
- 4/8/16 channel synchronous realtime playback, GRID interface & smart search
- HDMI/VGA/TV simultaneous video output
- Support 8 SATA HDDs up to 32TB, 1 eSATA, 4 USB2.0
- 3D intelligent positioning with Dahua PTZ dome camera
- ONVIF Version 2.3 conformance
- Support Multi-brand network cameras: Dahua, Arecont Vision, AXIS, Bosch, Brickcom, Canon, CP Plus, Dynacolor, Honeywell, Panasonic, Pelco, Samsung, Sanyo, Sony, Videosec, Vivotek, and etc.
- Multiple network monitoring: Web viewer, CMS(DSS/Smart PSS)&Smart Phone(DMSS)

### System Connection

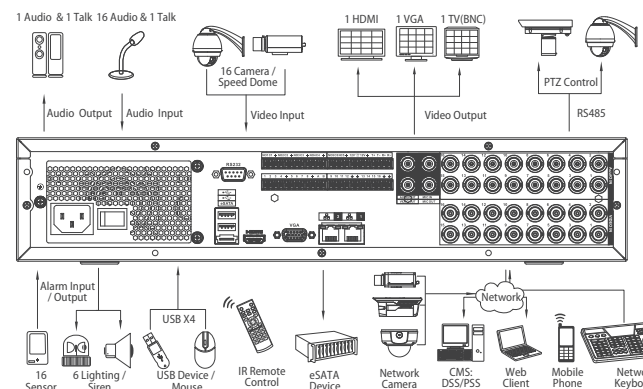

\* Takes HCVR5816S-V2 as an example

### Technical Specifications

Model	DH-HCVR5804	DH-HCVR5808	DH-HCVR5816S-V2
<b>System</b>			
Main Processor	Embedded processor		
Operating System	Embedded LINUX		
<b>Video</b>			
Input			
Standard	HDCVI Analog IP		
<b>Audio</b>			
Input			
Output			
Two-way Talk			
<b>Display</b>			
Interface			
Resolution			
Display Split			
Privacy Masking			
<b>Recording</b>			
Video/Audio Compression			
Record Rate	Main stream		
	Extra stream		
Bit Rate			
Recording Mode			
Recording Interval			
<b>Video Detection &amp; Alarm</b>			
Trigger Event			
Video Detection			
Alarm Input			
Relay Output			
<b>Playback &amp; Backup</b>			
Sync Playback			
Search Mode			
<b>Playback Functions</b>			
Backup Mode			
<b>Network</b>			
Ethernet			
<b>Network Functions</b>			
Max. User Access			
Smart Phone			
<b>Storage</b>			
Internal HDD			
External HDD			
<b>Auxiliary Interface</b>			
USB Interface			
RS232			
RS485			
<b>General</b>			
Power Supply			
Power Consumption			
Working Environment			
Dimension(W×D×H)			
Weight			

# DH-HCVR5404/5408/5416L-V2



4/8/16CH Tribrid 720P-Pro 1.5U HDCVI DVR



## Features

- Support HDCVI/Analog/IP Video input
- H.264 dual-stream video compression
- HCVR5404/5408/5416L-V2: All channel 720P realtime or 1080P non-realtime recording
- 4/8/16 channel synchronous realtime playback, GRID interface & smart search
- HDMI/VGA/TV simultaneous video output
- Support 4 SATA HDDs up to 16TB, 1 eSATA, 3 USB2.0
- 3D intelligent positioning with Dahua PTZ dome camera
- ONVIF Version 2.3 conformance
- Support Multi-brand network cameras: Dahua, Arecont Vision, AXIS, Bosch, Brickcom, Canon, CP Plus, Dynacolor, Honeywell, Panasonic, Pelco, Samsung, Sanyo, Sony, Videosec, Vivotech, and etc.
- Multiple network monitoring: Web viewer, CMS(DSS/Smart PSS)&Smart Phone(DMSS)

## System Connection

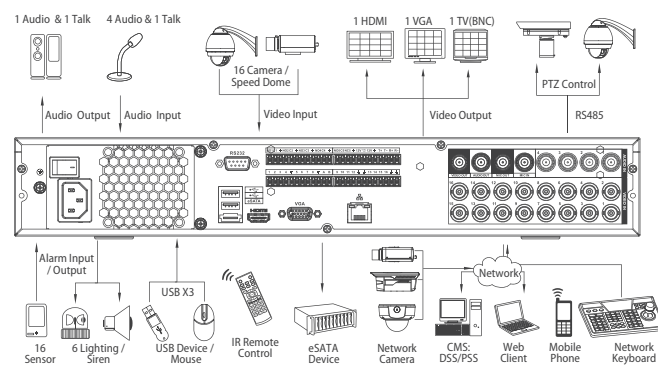

\*Takes HCVR5416L-V2 as an example

## Technical Specifications

Model	DH-HCVR5404L-V2	DH-HCVR5408L-V2	DH-HCVR5416L-V2
<b>System</b>			
Main Processor	Embedded processor		
Operating System	Embedded LINUX		
<b>Video</b>			
Input	4 channel, BNC	8 channel, BNC	16 channel, BNC
Standard	HDCVI	1080P/720P HDCVI Camera	
	Analog	NTSC/PAL	
	IP	Support 2ch 1080P/720P IP Camera	
<b>Audio</b>			
Input	4 channel, BNC		
Output	1 channel, BNC		
Two-way Talk	1 channel Input, 1 channel Output, BNC		
<b>Display</b>			
Interface	1 HDMI, 1 VGA, 1 TV		
Resolution	1920×1080, 1280×1024, 1280×720, 1024×768		
Display Split	1/4	1/4/8/9	1/4/8/9/16
Privacy Masking	4 rectangular zones (each camera)		
OSD	Camera title, Time, Video loss, Camera lock, Motion detection, Recording		
<b>Recording</b>			
Video/Audio Compression	H.264/G.711		
Record Rate	Main stream	1080P(1~12/15fps)/720P/960H/D1/HD1/2CIF/CIF(1~25/30fps)	
	Extra stream	CIF/QCIF(1~25/30fps)	
Bit Rate	48~4096Kb/s		
Record Mode	Manual, Schedule(Regular(Continuous), MD), Stop		
Record Interval	1~60 min (default: 60 min), Pre-record: 1~30 sec, Post-record: 10~300 sec		
<b>Video Detection &amp; Alarm</b>			
Trigger Event	Recording, PTZ, Tour, Alarm out, Video Push, Email, FTP, Spot, Snapshot, Buzzer & Screen tips		
Video Detection	Motion Detection, MD Zones: 396(22×18), Video Loss & Camera Blank		
Alarm Input	4 channel	8 channel	16 channel
Relay Output	6 channel		
<b>Playback &amp; Backup</b>			
Sync Playback	1/4	1/4/9	1/4/9/16
Search Mode	Time/Date, MD & Exact search (accurate to second)		
Playback Functions	Play, Pause, Stop, Rewind, Fast play, Slow play, Next file, Previous file, Next camera, Previous camera, Full screen, Repeat, Shuffle, Backup selection, Digital zoom		
Backup Mode	USB Device/eSATA Device/Internal SATA burner/Network		
<b>Network</b>			
Ethernet	RJ-45 port (10/100M/1000M)		
Network Functions	HTTP, IPv4/IPv6, TCP/IP, UPNP, RTSP, UDP, SMTP, NTP, DHCP, DNS, PPPoE, DDNS, FTP, IP Filter, SNMP, P2P		
Max. User Access	128 users		
Smart Phone	iPhone, iPad, Android, Windows Phone		
<b>Storage</b>			
Internal HDD	4 SATA ports(4 HDDs or 3HDDs+1 CD/DVD-RW), up to 16TB		
External HDD	1 eSATA port		
<b>Auxiliary Interface</b>			
USB Interface	3 ports (2 Rear), USB2.0		
RS232	1 port, For PC communication & Keyboard		
RS485	1 port RS485 for PTZ control, 1 port RS422 for Keyboard		
<b>General</b>			
Power Supply	AC 100~240 V, 50/60 Hz		
Power Consumption	40W(Without HDD)		
Working Environment	-10°C ~+55°C / 10%~90%RH / 86~106kpa		
Dimension(W×D×H)	1.5U, 440mm×416mm×68mm		
Weight	6kg (without HDD)		

# DH-HCVR5204/5208/5216A-S2



NEW

4/8/16CH Tribrid 720P-Pro 1U HDCVI DVR



## Features

- Support HDCVI/Analog/IP Video input
- H.264 dual-stream video compression
- HCVR5204/5208/5216A-S2: All channel 720P realtime or 1080P non-realtime recording
- HDMI/VGA simultaneous video output
- 4/8/16 channel synchronous realtime playback, GRID interface & smart search
- Support Multi-brand network cameras: Dahua, Arecont Vision, AXIS, Bosch, Brickcom, Canon, CP Plus, Dynacolor, Honeywell, Panasonic, Pelco, Samsung, Sanyo, Sony, Videosec, Vivotek and etc.
- ONVIF Version 2.4 conformance
- Support 2 SATA HDDs up to 8TB, 2 USB2.0
- 3D intelligent positioning with Dahua PTZ dome camera
- Multiple network monitoring: Web viewer, CMS(DSS/Smart PSS)&Smart Phone(DMSS)

## System Connection

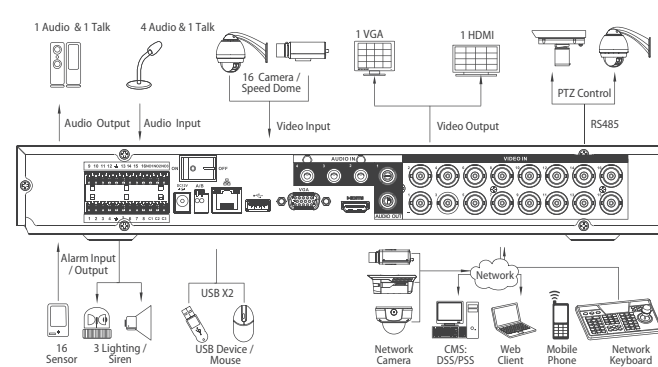

\*Takes HCVR5216A-S2 as an example

## Technical Specifications

Model	DH-HCVR5204A-S2	DH-HCVR5208A-S2	DH-HCVR5216A-S2
<b>System</b>			
Main Processor	Embedded processor		
Operating System	Embedded LINUX		
<b>Video</b>			
Input	4 channel, BNC	8 channel, BNC	16 channel, BNC
Standard	HDCVI	1080P/720P HDCVI Camera	
	Analog	NTSC/PAL	
	IP	Support 2ch 1080P/720P IP Camera	
<b>Audio</b>			
Input	4 channel, RCA		
Output	1 channel, RCA		
Two-way Talk	Reuse audio input/output channel 1		
<b>Display</b>			
Interface	1 HDMI, 1 VGA		
Resolution	1920×1080, 1280×1024, 1280×720, 1024×768		
Display Split	1/4	1/4/8/9	1/4/8/9/16
Privacy Masking	4 rectangular zones (each camera)		
OSD	Camera title, Time, Video loss, Camera lock, Motion detection, Recording		
<b>Recording</b>			
Video/Audio Compression	H.264/G.711		
Record Rate	Main stream	1080P(1~15fps)/720P/960H/D1 (1~25/30fps)	
	Extra stream	CIF/QCIF(1~25/30fps), D1	
Bit Rate	96~4096Kb/s		
Record Mode	Manual, Schedule(Regular(Continuous), MD), Stop		
Record Interval	1~60 min (default: 60 min), Pre-record: 1~30 sec, Post-record: 10~300 sec		
<b>Video Detection &amp; Alarm</b>			
Trigger Events	Recording, PTZ, Tour, Alarm out, Video Push, Email, FTP, Snapshot, Buzzer & Screen tips		
Video Detection	Motion Detection, MD Zones: 396(22×18), Video Loss & Camera Blank		
Alarm Input	8 channel	8 channel	16 channel
Relay Output	3 channel		
<b>Playback &amp; Backup</b>			
Sync Playback	1/4	1/4/9	1/4/9/16
Search Mode	Time/Date, MD & Exact search (accurate to second)		
Playback Functions	Play, Pause, Stop, Rewind, Fast play, Slow play, Next file, Previous file, Next camera, Previous camera, Full screen, Repeat, Shuffle, Backup selection, Digital zoom		
Backup Mode	USB Device/Internal SATA burner/Network		
<b>Network</b>			
Ethernet	RJ-45 port (10/100M)		RJ-45 port (10/100M/1000M)
Network Functions	HTTP, IPv4/IPv6, TCP/IP, UPNP, RTSP, UDP, SMTP, NTP, DHCP, DNS, PPPoE, DDNS, FTP, IP Filter, SNMP, P2P		
Max. User Access	128 users		
Smart Phone	iPhone, iPad, Android, Windows Phone		
<b>Storage</b>			
Internal HDD	2 SATA ports, up to 8TB		
<b>Auxiliary Interface</b>			
USB Interface	2 ports(1 Rear), USB2.0		
RS485	1 port, For PTZ control		
<b>General</b>			
Power Supply	DC12V/4A		DC12V/5A
Power Consumption	15W(Without HDD)		
Working Environment	-10°C ~+55°C / 10%~90%RH / 86~106kpa		
Dimension(W×D×H)	1U, 375mm×285mm×55mm		
Weight	2.35kg (without HDD)		

HDCVI DVR

HDCVI Camera

HDCVI PTZ Camera

# DH-HCVR5216AN-S2 NEW



## 16CH Tribrid 720P-Pro 1U HDCVI DVR



### Features

- Support HDCVI/Analog/IP Video input
- H.264 dual-stream video compression
- HCVR5216AN-S2: All channel 720P realtime or 1080P non-realtime recording
- HDMI/VGA simultaneous video output
- 16 channel synchronous realtime playback, GRID interface & smart search
- Support Multi-brand network cameras: Dahua, Arecont Vision, AXIS, Bosch, Brickcom, Canon, CP Plus, Dynacolor, Honeywell, Panasonic, Pelco, Samsung, Sanyo, Sony, Videosec, Vivotek and etc.
- ONVIF Version 2.4 conformance
- 3D intelligent positioning with Dahua PTZ dome camera
- Support 2 SATA HDDs up to 8TB, 2 USB2.0
- Multiple network monitoring: Web viewer, CMS(DSS/Smart PSS)&Smart Phone(DMSS)

### System Connection

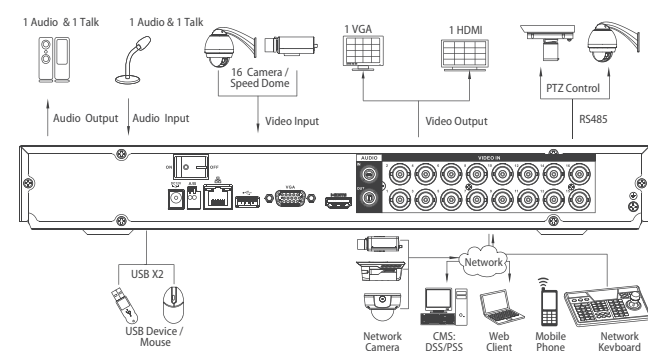

\*Takes HCVR5216AN-S2 as an example

### Technical Specifications

Model	DH-HCVR5216AN-S2	
<b>System</b>		
Main Processor	Embedded processor	
Operating System	Embedded LINUX	
<b>Video</b>		
Input	16 channel, BNC	
Standard	HDCVI	1080P/720P HDCVI Camera
	Analog	NTSC/PAL
	IP	Support 2ch 1080P/720P IP Camera
<b>Audio</b>		
Input	1 channel, RCA	
Output	1 channel, RCA	
Two-way Talk	Reuse audio input/output channel 1	
<b>Display</b>		
Interface	1 HDMI, 1 VGA	
Resolution	1920×1080, 1280×1024, 1280×720, 1024×768	
Display Split	1/4/8/9/16	
Privacy Masking	4 rectangular zones (each camera)	
OSD	Camera title, Time, Video loss, Camera lock, Motion detection, Recording	
<b>Recording</b>		
Video/Audio Compression	H.264/G.711	
Resolution	1080P(1920×1080)/720P(1280×720)/960H(960×576/960×480)/D1/4CIF(704×576/704×480) / CIF(352×288/352×240) / QCIF(176×144/176×120)	
Record Rate	Main stream	1080P(1~15fps)/720P/960H/D1 (1~25/30fps)
	Extra stream	CIF/QCIF (1~25/30fps), D1
Bit Rate	96~4096Kb/s	
Record Mode	Manual, Schedule(Regular/Continuous), MD, Stop	
Record Interval	1~60 min (default: 60 min), Pre-record: 1~30 sec, Post-record: 10~300 sec	
<b>Video Detection</b>		
Trigger Event	Recording, PTZ, Tour, Alarm out, Video Push, Email, FTP, Snapshot, Buzzer & Screen tips	
Video Detection	Motion Detection, MD Zones: 396(22×18), Video Loss & Camera Blank	
<b>Playback &amp; Backup</b>		
Sync Playback	1/4/9/16	
Search Mode	Time/Date, MD & Exact search (accurate to second)	
Playback Functions	Play, Pause, Stop, Rewind, Fast play, Slow play, Next file, Previous file, Next camera, Previous camera, Full screen, Repeat, Shuffle, Backup selection, Digital zoom	
Backup Mode	USB Device/Internal SATA burner/Network	
<b>Network</b>		
Ethernet	RJ-45 port (10/100M/1000M)	
Network Functions	HTTP, IPv4/IPv6, TCP/IP, UPNP, RTSP, UDP, SMTP, NTP, DHCP, DNS, PPPoE, DDNS, FTP, IP Filter, SNMP, P2P	
Max. User Access	128 users	
Smart Phone	iPhone, iPad, Android, Windows Phone	
<b>Storage</b>		
Internal HDD	2 SATA ports, up to 8TB	
<b>Auxiliary Interface</b>		
USB Interface	2 ports(1 Rear), USB2.0	
RS485	1 port, For PTZ control	
<b>General</b>		
Power Supply	DC12V/4A	
Power Consumption	15W(without HDD)	
Working Environment	-10°C ~+55°C / 10%~90%RH / 86~106kpa	
Dimension(W×D×H)	1U, 375mm×285mm×55mm	
Weight	2.35kg (without HDD)	

# DH-HCVR5104/5108/5116HE-S2 NEW



## 4/8/16CH Tribrid 720P-Pro Mini 1U HDCVI DVR



### Features

- Support HDCVI/Analog/IP Video input
- H.264 dual-stream video compression
- HCVR5104/5108/5116HE-S2: All channel 720P realtime or 1080P non-realtime recording
- HDMI/VGA simultaneous video output
- 4/8/16 channel synchronous realtime playback, GRID interface & smart search
- Support Multi-brand network cameras: Dahua, Arecont Vision, AXIS, Bosch, Brickcom, Canon, CP Plus, Dynacolor, Honeywell, Panasonic, Pelco, Samsung, Sanyo, Sony, Videosec, Vivotek and etc.
- ONVIF Version 2.4 conformance
- Support 1 SATA HDD up to 4TB, 2 USB2.0
- 3D intelligent positioning with Dahua PTZ dome camera
- Multiple network monitoring: Web viewer, CMS(DSS/Smart PSS)&Smart Phone(DMSS)

### System Connection

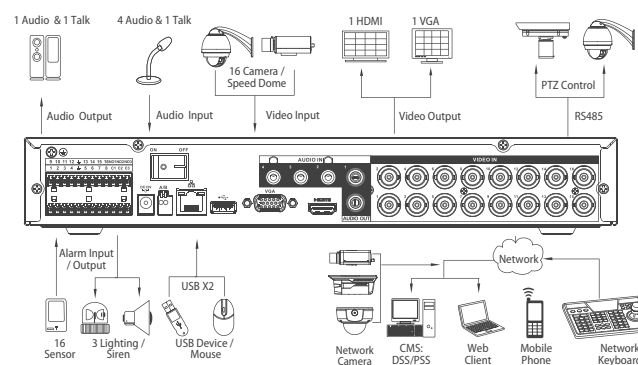

\*Takes HCVR5116HE-S2 as an example

### Technical Specifications

Model	DH-HCVR5104HE-S2	DH-HCVR5108HE-S2	DH-HCVR5116HE-S2
<b>System</b>			
Main Processor	Embedded processor		
Operating System	Embedded LINUX		
<b>Video</b>			
Input	4 channel, BNC	8 channel, BNC	16 channel, BNC
Standard	Analog	NTSC/PAL	
	HDCVI	1080P/720P HDCVI Camera	
	IP	Support 2ch 1080P/720P IP Camera	
<b>Audio</b>			
Input	4 channel, RCA		
Output	1 channel, RCA		
Two-way Talk	Reuse audio input/output channel 1		
<b>Display</b>			
Interface	1 HDMI, 1 VGA		
Resolution	1920×1080, 1280×1024, 1280×720, 1024×768		
Display Split	1/4	1/4/8/9	1/4/8/9/16
Privacy Masking	4 rectangular zones (each camera)		
OSD	Camera title, Time, Video loss, Camera lock, Motion detection, Recording		
<b>Recording</b>			
Video/Audio Compression	H.264/G.711		
Record Rate	Main stream	1080P(1~15fps)/720P/960H/D1 (1~25/30fps)	
	Extra stream	CIF/QCIF(1~25/30fps), D1	
Bit Rate	96~4096Kb/s		
Record Mode	Manual, Schedule(Regular/Continuous), MD, Stop		
Record Interval	1~60 min (default: 60 min), Pre-record: 1~30 sec, Post-record: 10~300 sec		
<b>Video Detection</b>			
Trigger Events	Recording, PTZ, Tour, Alarm out, Video Push, Email, FTP, Snapshot, Buzzer & Screen tips		
Video Detection	Motion Detection, MD Zones: 396(22×18), Video Loss & Camera Blank		
Alarm Input	4 channel	8 channel	16 channel
Relay Output	3 channel		
<b>Playback &amp; Backup</b>			
Sync Playback	1/4	1/4/9	1/4/9/16
Search Mode	Time/Date, MD & Exact search (accurate to second)		
Playback Functions	Play, Pause, Stop, Rewind, Fast play, Slow play, Next file, Previous file, Next camera, Previous camera, Full screen, Repeat, Shuffle, Backup selection, Digital zoom		
Backup Mode	USB Device/Internal SATA burner/Network		
<b>Network</b>			
Ethernet	RJ-45 port (10/100M)	[RJ-45 port(10/100M/1000M)]	
Network Functions	HTTP, IPv4/IPv6, TCP/IP, UPNP, RTSP, UDP, SMTP, NTP, DHCP, DNS, PPPoE, DDNS, FTP, IP Filter, SNMP, P2P		
Max. User Access	128 users		
Smart Phone	iPhone, iPad, Android, Windows Phone		
<b>Storage</b>			
Internal HDD	1 SATA port, up to 4TB		
<b>Auxiliary Interface</b>			
USB Interface	2 ports(1 Rear), USB2.0		
RS485	1 port, For PTZ Control		
<b>General</b>			
Power Supply	DC12V/2A		DC12V/3A
Power Consumption	10W(without HDD)		
Working Environment	-10°C ~+55°C / 10%~90%RH / 86~106kpa		
Dimension(W×D×H)	Mini 1U, 325mm×255mm×55mm		
Weight	1.5kg (without HDD)		

HDCVI DVR  
HDCVI Camera  
HDCVI PTZ Camera

# DH-HCVR5104/5108/5116H-S2 NEW



4/8/16CH Tribrid 720P-Pro Mini 1U HDCVI DVR



## Features

- Support HDCVI/Analog/IP Video input
- H.264 dual-stream video compression
- HCVR5104/5108/5116H-S2: All channel 720P realtime or 1080P non-realtime recording
- HDMI/VGA simultaneous video output
- 4/8/16 channel synchronous realtime playback, GRID interface & smart search
- Support Multi-brand network cameras: Dahua, Arecont Vision, AXIS, Bosch, Brickcom, Canon, CP Plus, Dynacolor, Honeywell, Panasonic, Pelco, Samsung, Sanyo, Sony, Videosec, Vivotek and etc.
- ONVIF Version 2.4 conformance
- Support 1 SATA HDD up to 4TB, 2 USB2.0
- 3D intelligent positioning with Dahua PTZ dome camera
- Multiple network monitoring: Web viewer, CMS(DSS/Smart PSS)&Smart Phone(DMSS)

## System Connection

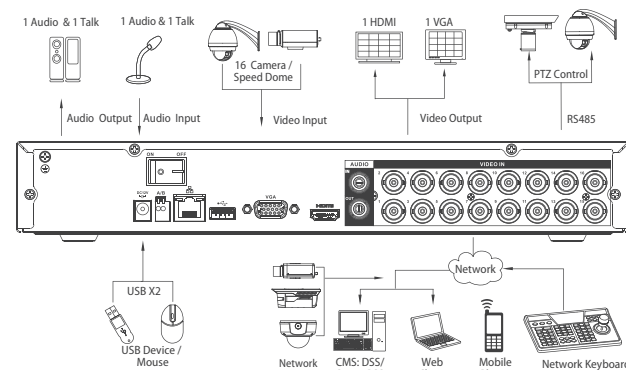

\*Takes HCVR5116H-S2 as an example

## Technical Specifications

Model	DH-HCVR5104H-S2	DH-HCVR5108H-S2	DH-HCVR5116H-S2
<b>System</b>			
Main Processor	Embedded processor		
Operating System	Embedded LINUX		
<b>Video</b>			
Input	4 channel, BNC	8 channel, BNC	16 channel, BNC
Standard	Analog	NTSC/PAL	
	HDCVI	1080P/720P HDCVI Camera	
	IP	Support 2ch 1080P/720P IP Camera	
<b>Audio</b>			
Input	1 channel, RCA		
Output	1 channel, RCA		
Two-way Talk	Reuse audio input/output channel 1		
<b>Display</b>			
Interface	1 HDMI, 1 VGA		
Resolution	1920×1080, 1280×1024, 1280×720, 1024×768		
Display Split	1/4	1/4/8/9	1/4/8/9/16
Privacy Masking	4 rectangular zones (each camera)		
OSD	Camera title, Time, Video loss, Camera lock, Motion detection, Recording		
<b>Recording</b>			
Video/Audio Compression	H.264/G.711		
Record Rate	Main stream	1080P(1~15fps)/ 720P/960H/D1 (1~25/30fps)	
	Extra stream	CIF/QCIF(1~25/30fps), D1	
Bit Rate	96~4096Kb/s		
Record Mode	Manual, Schedule(Regular(Continuous), MD), Stop		
Record Interval	1~60 min (default: 60 min), Pre-record: 1~30 sec, Post-record: 10~300 sec		
<b>Video Detection &amp; Alarm</b>			
Trigger Events	Recording, PTZ, Tour, Alarm out, Video Push, Email, FTP, Snapshot, Buzzer & Screen tips		
Video Detection	Motion Detection, MD Zones: 396(22×18), Video Loss & Camera Blank		
<b>Playback &amp; Backup</b>			
Sync Playback	1/4	1/4/9	1/4/9/16
Search Mode	Time/Date, MD & Exact search (accurate to second)		
Playback Functions	Play, Pause, Stop, Rewind, Fast play, Slow play, Next file, Previous file, Next camera, Previous camera, Full screen, Repeat, Shuffle, Backup selection, Digital zoom		
Backup Mode	USB Device/Internal SATA burner/Network		
<b>Network</b>			
Ethernet	RJ-45 port (10/100M)	RJ-45 port (10/100M/1000M)	
Network Functions	HTTP, IPv4/IPv6, TCP/IP, UPNP, RTSP, UDP, SMTP, NTP, DHCP, DNS, PPPoE, DDNS, FTP, IP Filter, SNMP, P2P		
Max. User Access	128 users		
Smart Phone	iPhone, iPad, Android, Windows Phone		
<b>Storage</b>			
Internal HDD	1 SATA port, up to 4TB		
<b>Auxiliary Interface</b>			
USB Interface	2 ports(1 Rear), USB2.0		
RS485	1 port, For PTZ Control		
<b>General</b>			
Power Supply	DC12V/2A		DC12V/3A
Power Consumption	10W(without HDD)		
Working Environment	-10°C ~+55°C / 10%~90%RH / 86~106kpa		
Dimension(W×D×H)	Mini 1U, 325mm×255mm×55mm		
Weight	1.5kg (without HDD)		

# DH-HCVR5104/5108C-S2 NEW



4/8CH Tribrid 720P-Pro Smart 1U HDCVI DVR



## Features

- Support HDCVI/Analog/IP Video input
- H.264 dual-stream video compression
- HCVR5104/5108C-S2: All channel 720P realtime or 1080P non-realtime recording
- HDMI/VGA simultaneous video output
- 4/8 channel synchronous realtime playback, GRID interface & smart search
- Support Multi-brand network cameras: Dahua, Arecont Vision, AXIS, Bosch, Brickcom, Canon, CP Plus, Dynacolor, Honeywell, Panasonic, Pelco, Samsung, Sanyo, Sony, Videosec, Vivotek and etc.
- ONVIF Version 2.4 conformance
- Support 1 SATA HDD up to 4TB, 2 USB2.0
- 3D intelligent positioning with Dahua PTZ dome camera
- Multiple network monitoring: Web viewer, CMS(DSS/Smart PSS)&Smart Phone(DMSS)

## System Connection

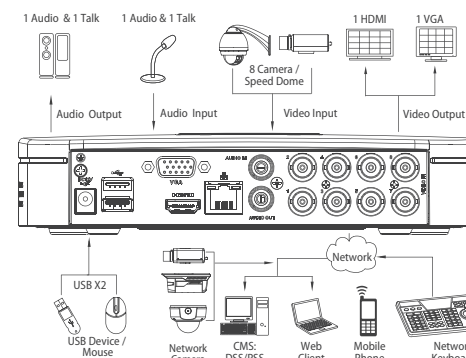

\*Takes HCVR5108C-S2 as an example

## Technical Specifications

Model	DH-HCVR5104C-S2	DH-HCVR5108C-S2
<b>System</b>		
Main Processor	Embedded processor	
Operating System	Embedded LINUX	
<b>Video</b>		
Input	4 channel, BNC	8 channel, BNC
Standard	Analog	NTSC/PAL
	HDCVI	1080P/720P HDCVI Camera
	IP	Support 2ch 1080P/720P IP Camera
<b>Audio</b>		
Input	1 channel, RCA	
Output	1 channel, RCA	
Two-way Talk	Reuse audio input/output channel 1	
<b>Display</b>		
Interface	1 HDMI, 1 VGA	
Resolution	1920×1080, 1280×1024, 1280×720, 1024×768	
Display Split	1/4	1/4/8/9
Privacy Masking	4 rectangular zones (each camera)	
OSD	Camera title, Time, Video loss, Camera lock, Motion detection, Recording	
<b>Recording</b>		
Video/Audio Compression	H.264/G.711	
Record Rate	Main stream	1080P(1~15fps)/720P/960H/D1(1~25/30fps)
	Extra stream	CIF/QCIF(1~25/30fps), D1
Bit Rate	96~4096Kb/s	
Record Mode	Manual, Schedule(Regular(Continuous), MD), Stop	
Record Interval	1~60 min (default: 60 min), Pre-record: 1~30 sec, Post-record: 10~300 sec	
<b>Video Detection</b>		
Trigger Events	Recording, PTZ, Tour, Video Push, Email, FTP, Snapshot, Buzzer & Screen tips	
Video Detection	Motion Detection, MD Zones: 396(22×18), Video Loss & Camera Blank	
<b>Playback &amp; Backup</b>		
Sync Playback	1/4	1/4/9
Search Mode	Time/Date, MD & Exact search (accurate to second)	
Playback Functions	Play, Pause, Stop, Rewind, Fast play, Slow play, Next file, Previous file, Next camera, Previous camera, Full screen, Repeat, Shuffle, Backup selection, Digital zoom	
Backup Mode	USB Device/Internal SATA burner/Network	
<b>Network</b>		
Ethernet	RJ-45 port (10/100M)	
Network Functions	HTTP, IPv4/IPv6, TCP/IP, UPNP, RTSP, UDP, SMTP, NTP, DHCP, DNS, PPPoE, DDNS, FTP, IP Filter, SNMP, P2P	
Max. User Access	128 users	
Smart Phone	iPhone, iPad, Android, Windows Phone	
<b>Storage</b>		
Internal HDD	1 SATA port, up to 4TB	
<b>Auxiliary Interface</b>		
USB Interface	2 ports(2 Rear), USB2.0	
<b>General</b>		
Power Supply	DC12V/2A	
Power Consumption	10W(without HDD)	
Working Environment	-10°C ~+55°C / 10%~90%RH / 86~106kpa	
Dimension(W×D×H)	Smart 1U, 205mm×205mm×40mm	
Weight	0.5kg (without HDD)	

HDCVI DVR  
HDCVI Camera  
HDCVI PTZ Camera

# DH-HCVR504



## 4CH 720P-Pro Smart Box HDCVI DVR



### Features

- Up to 4 cameras input
- H.264 dual-stream video compression
- HCVR504: All channel 720P realtime or 1080P non-realtime recording
- HDMI/VGA simultaneous video output
- 4 channel synchronous realtime playback, GRID interface & smart search
- Support Multi-brand network cameras: Dahua, Arecont Vision, AXIS, Bosch, Brickcom, Canon, CP Plus, Dynacolor, Honeywell, Panasonic, Pelco, Samsung, Sanyo, Sony, Videosec, Vivotek and etc.
- ONVIF Version 2.3 conformance
- Support 1 SATA 2.5-inch Removable HDD up to 2TB, 2 USB2.0
- 3D intelligent positioning with Dahua PTZ dome camera
- Multiple network monitoring: Web viewer, CMS(DSS/Smart PSS)&Smart Phone(DMSS)

### System Connection

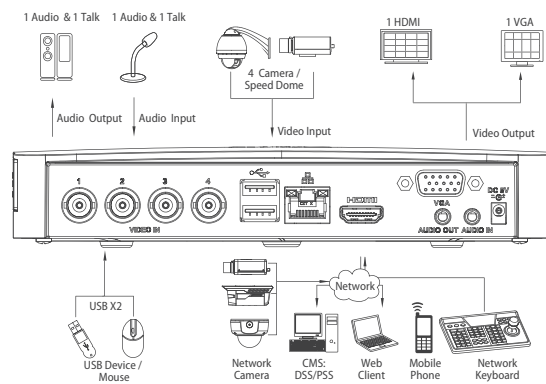

\*Takes HCVR504 as an example

### Technical Specifications

Model	DH-HCVR504	
System		
Main Processor	Embedded processor	
Operating System	Embedded LINUX	
Video		
Input	4 channel, BNC	
Standard	HDCVI	1080P/720P HDCVI Camera
	IP	Support 2ch 1080P/720P IP Camera
Audio		
Input	1 channel, 3.5mm	
Output	1 channel, 3.5mm	
Two-way Talk	Reuse audio input/output channel 1	
Display		
Interface	1 HDMI, 1 VGA	
Resolution	1920×1080, 1280×1024, 1280×720, 1024×768	
Display Split	1/4	
Privacy Masking	4 rectangular zones (each camera)	
OSD	Camera title, Time, Video loss, Camera lock, Motion detection, Recording	
Recording		
Video/Audio Compression	H.264/G.711	
Resolution	1080P(1920×1080)/720P(1280×720)/960H(960×576/960×480)/D1/4CIF(704×576/704×480) / CIF(352×288/352×240) / QCIF(176×144/176×120)	
Record Rate	Main stream	1080P(1~12/15fps)/720P/960H/D1/HD1/2CIF/CIF(1~25/30fps)
	Extra stream	CIF/QCIF(1~25/30fps), D1(1~12/15fps)
Bit Rate	48~4096Kb/s	
Record Mode	Manual, Schedule(Regular(Continuous), MD), Stop	
Record Interval	1~60 min (default: 60 min), Pre-record: 1~30 sec, Post-record: 10~300 sec	
Video Detection		
Trigger Events	Recording, PTZ, Tour, Video Push, Email, FTP, Spot, Snapshot, Buzzer & Screen tips	
Video Detection	Motion Detection, MD Zones: 396(22×18), Video Loss & Camera Blank	
Playback & Backup		
Sync Playback	1/4	
Search Mode	Time/Date, MD & Exact search (accurate to second)	
Playback Functions	Play, Pause, Stop, Rewind, Fast play, Slow play, Next file, Previous file, Next camera, Previous camera, Full screen, Repeat, Shuffle, Backup selection, Digital zoom	
Backup Mode	USB Device/Internal SATA burner/Network	
Network		
Ethernet	RJ-45 port (10/100M)	
Network Functions	HTTP, IPv4/IPv6, TCP/IP, UPNP, RTSP, UDP, SMTP, NTP, DHCP, DNS, PPOE, DDNS, FTP, IP Filter, SNMP, P2P	
Max. User Access	128 users	
Smart Phone	iPhone, iPad, Android, Windows Phone	
Storage		
Internal HDD	1 SATA port, up to 2TB	
Auxiliary Interface		
USB Interface	2 ports(2 Rear), USB2.0	
General		
Power Supply	DC5V/2A	
Power Consumption	10W(without HDD)	
Working Environment	-10°C ~+55°C / 10%~90%RH / 86~106kpa	
Dimension(W×D×H)	190mm×130mm×35mm	
Weight	300g (without HDD)	



# DH-HCVR4224/4232L-S2 NEW

## 24/32CH Tribrid 720P-Lite 1.5U HDCVI DVR



### Features

- Support HDCVI/Analog/IP Video input
- H.264 dual-stream video compression
- HCVR4224/4232L-S2: All channel 720P recording
- 8 channel synchronous realtime playback, GRID interface & smart search
- HDMI/VGA/TV simultaneous video output
- Support 2 SATA HDDs up to 8TB, 2 USB2.0
- ONVIF Version 2.4 conformance
- Support Multi-brand network cameras: Dahua, Arecont Vision, AXIS, Bosch, Brickcom, Canon, CP Plus, Dynacolor, Honeywell, Panasonic, Pelco, Samsung, Sanyo, Sony, Videosec, Vivotek and etc.
- 3D intelligent positioning with Dahua PTZ dome camera
- Multiple network monitoring: Web viewer, CMS(DSS/Smart PSS)&Smart Phone(DMSS)

### System Connection

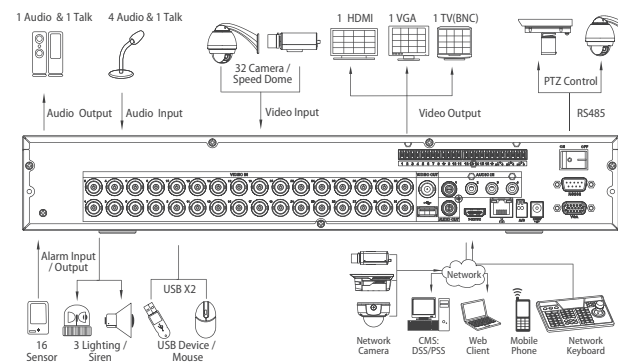

\*Takes HCVR4232L-S2 as an example

### Technical Specifications

Model	DH-HCVR4224L-S2	DH-HCVR4232L-S2
System		
Main Processor	Embedded processor	
Operating System	Embedded LINUX	
Video		
Input	24 channel, BNC	32 channel, BNC
Standard	HDCVI	720P HDCVI Camera
	Analog	NTSC/PAL
	IP	Support 2ch 1080P/4ch 720P IP Camera
Audio		
Input	4 channel, RCA	
Output	1 channel, RCA	
Two-way Talk	Reuse audio input/output channel 1	
Display		
Interface	1 HDMI, 1 VGA	
Resolution	1920×1080, 1280×1024, 1280×720, 1024×768	
Display Split	1/4/8/9/16/25	1/4/8/9/16/25/36
Privacy Masking	4 rectangular zones (each camera)	
OSD	Camera title, Time, Video loss, Camera lock, Motion detection, Recording	
Recording		
Video/Audio Compression	H.264/G.711	
Record Rate	Main stream	720P/960H/D1(1~25/30fps)
	Extra stream	CIF/QCIF(1~12/15fps)
Bit Rate	32~4096Kb/s	
Record Mode	Manual, Schedule(Regular(Continuous), MD), Stop	
Record Interval	1~60 min (default: 60 min), Pre-record: 1~30 sec, Post-record: 10~300 sec	
Video Detection & Alarm		
Trigger Events	Recording, PTZ, Tour, Alarm out, Video Push, Email, FTP, Snapshot, Buzzer & Screen tips	
Video Detection	Motion Detection, MD Zones: 396(22×18), Video Loss & Camera Blank	
Alarm Input	16 channel	
Relay Output	3 channel	
Playback & Backup		
Sync Playback	1/4/9/16	
Search Mode	Time/Date, MD & Exact search (accurate to second)	
Playback Functions	Play, Pause, Stop, Rewind, Fast play, Slow play, Next file, Previous file, Next camera, Previous camera, Full screen, Repeat, Shuffle, Backup selection, Digital zoom	
Backup Mode	USB Device/Internal SATA burner/Network	
Network		
Ethernet	RJ-45 port (10/100M/1000M)	
Network Functions	HTTP, IPv4/IPv6, TCP/IP, UPNP, RTSP, UDP, SMTP, NTP, DHCP, DNS, PPOE, DDNS, FTP, IP Filter, SNMP, P2P	
Max. User Access	128 users	
Smart Phone	iPhone, iPad, Android, Windows Phone	
Storage		
Internal HDD	2 SATA ports, up to 8TB	
Auxiliary Interface		
USB Interface	2 ports(1 Rear), USB2.0	
RS485	1 port, For PTZ control	
General		
Power Supply	DC12V/5A	
Power Consumption	15W(without HDD)	
Working Environment	-10°C ~+55°C / 10%~90%RH / 86~106kpa	
Dimension(W×D×H)	1.5U, 440mm×416mm×68mm	
Weight	2.35kg (without HDD)	

HDCVI DVR

HDCVI Camera

HDCVI PTZ Camera

# DH-HCVR4224/4232AN-S2 NEW



24/32CH Tribrid 720P-Lite 1U HDCVI DVR



## Features

- Support HDCVI/Analog/IP Video input
- H.264 dual-stream video compression
- HCVR4224/4232AN-S2: All channel 720P recording
- 8 channel synchronous realtime playback, GRID interface & smart search
- HDMI/VGA/TV simultaneous video output
- Support 2 SATA HDDs up to 8TB, 2 USB2.0
- ONVIF Version 2.4 conformance
- Support Multi-brand network cameras: Dahua, Arecont Vision, AXIS, Bosch, Brickcom, Canon, CP Plus, Dynacolor, Honeywell, Panasonic, Pelco, Samsung, Sanyo, Sony, Videosec, Vivotek and etc.
- 3D intelligent positioning with Dahua PTZ dome camera
- Multiple network monitoring: Web viewer, CMS(DSS/Smart PSS)&Smart Phone(DMSS)

## System Connection

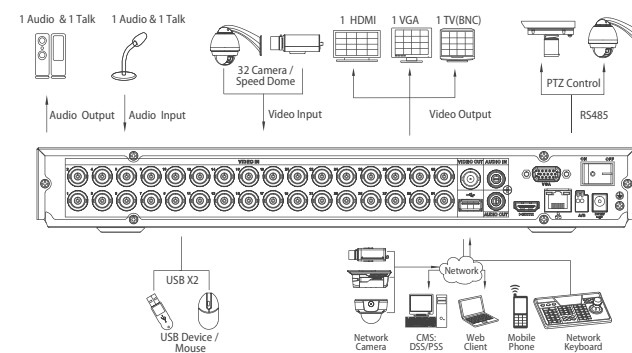

\*Takes HCVR4232AN-S2 as an example

## Technical Specifications

Model	DH-HCVR4224AN-S2	DH-HCVR4232AN-S2
<b>System</b>		
Main Processor	Embedded processor	
Operating System	Embedded LINUX	
<b>Video</b>		
Input	24 channel, BNC	32 channel, BNC
Standard	HDCVI	720P HDCVI Camera
	Analog	NTSC/PAL
	IP	Support 2ch 1080P/4ch 720P IP Camera
<b>Audio</b>		
Input	1 channel, RCA	
Output	1 channel, RCA	
Two-way Talk	Reuse audio input/output channel 1	
<b>Display</b>		
Interface	1 HDMI, 1 VGA, 1 TV	
Resolution	1920×1080, 1280×1024, 1280×720, 1024×768	
Display Split	1/4/8/9/16/25	1/4/8/9/16/25/36
Privacy Masking	4 rectangular zones (each camera)	
OSD	Camera title, Time, Video loss, Camera lock, Motion detection, Recording	
<b>Recording</b>		
Video/Audio Compression	H.264/G.711	
Record Rate	Main stream	720P/960H/D1(1~25/30fps)
	Extra stream	CIF/QCIF(1~12/15fps)
Bit Rate	32~4096Kb/s	
Record Mode	Manual, Schedule(Regular/Continuous), MD, Stop	
Record Interval	1~60 min (default: 60 min), Pre-record: 1~30 sec, Post-record: 10~300 sec	
<b>Video Detection</b>		
Trigger Events	Recording, PTZ, Tour, Alarm out, Video Push, Email, FTP, Snapshot, Buzzer & Screen tips	
Video Detection	Motion Detection, MD Zones: 396(22×18), Video Loss & Camera Blank	
<b>Playback &amp; Backup</b>		
Sync Playback	1/4/9/16	
Search Mode	Time/Date, MD & Exact search (accurate to second)	
Playback Functions	Play, Pause, Stop, Rewind, Fast play, Slow play, Next file, Previous file, Next camera, Previous camera, Full screen, Repeat, Shuffle, Backup selection, Digital zoom	
Backup Mode	USB Device/Internal SATA burner/Network	
<b>Network</b>		
Ethernet	RJ-45 port (10/100M/1000M)	
Network Functions	HTTP, IPv4/IPv6, TCP/IP, UPNP, RTSP, UDP, SMTP, NTP, DHCP, DNS, PPPOE, DDNS, FTP, IP Filter, SNMP, P2P	
Max. User Access	128 users	
Smart Phone	iPhone, iPad, Android, Windows Phone	
<b>Storage</b>		
Internal HDD	2 SATA ports, up to 8TB	
<b>Auxiliary Interface</b>		
USB Interface	2 ports(1 Rear), USB2.0	
RS485	1 port, For PTZ control	
<b>General</b>		
Power Supply	DC12V/5A	
Power Consumption	15W(without HDD)	
Working Environment	-10°C ~+55°C / 10%~90%RH / 86~106kpa	
Dimension(W×D×H)	1U, 375mm×285mm×55mm	
Weight	2.35kg (without HDD)	

# DH-HCVR4204/4208/4216A-S2 NEW



4/8/16CH Tribrid 720P-Lite 1U HDCVI DVR



## Features

- Support HDCVI/Analog/IP Video input
- H.264 dual-stream video compression
- HCVR4204/4208/4216A-S2: All channel 720P recording
- HDMI/VGA simultaneous video output
- 4/8/16 channel synchronous playback, GRID interface & smart search
- Support Multi-brand network cameras: Dahua, Arecont Vision, AXIS, Bosch, Brickcom, Canon, CP Plus, Dynacolor, Honeywell, Panasonic, Pelco, Samsung, Sanyo, Sony, Videosec, Vivotek and etc.
- ONVIF Version 2.4 conformance
- Support 2 SATA HDDs up to 8TB, 2 USB2.0
- 3D intelligent positioning with Dahua PTZ dome camera
- Multiple network monitoring: Web viewer, CMS(DSS/Smart PSS)&Smart Phone(DMSS)

## System Connection

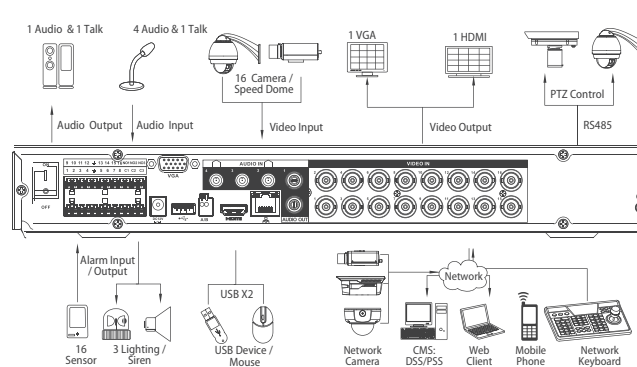

\*Takes HCVR4216A-S2 as an example

## Technical Specifications

Model	DH-HCVR4204A-S2	DH-HCVR4208A-S2	DH-HCVR4216A-S2
<b>System</b>			
Main Processor	Embedded processor		
Operating System	Embedded LINUX		
<b>Video</b>			
Input	4 channel, BNC	8 channel, BNC	16 channel, BNC
Standard	HDCVI	720P HDCVI Camera	
	Analog	NTSC/PAL	
	IP	Support 2ch 1080P/720P IP Camera	
<b>Audio</b>			
Input	4 channel, RCA		
Output	1 channel, RCA		
Two-way Talk	Reuse audio input/output channel 1		
<b>Display</b>			
Interface	1 HDMI, 1 VGA		
Resolution	1920×1080, 1280×1024, 1280×720, 1024×768		
Display Split	1/4	1/4/8/9	1/4/8/9/16
Privacy Masking	4 rectangular zones (each camera)		
OSD	Camera title, Time, Video loss, Camera lock, Motion detection, Recording		
<b>Recording</b>			
Video/Audio Compression	H.264/G.711		
Record Rate	Main stream	720P/960H/D1(1~25/30fps)	1*720P(1~25/30fps) +7*(1~15fps)/960H/D1 (1~25/30fps)
	Extra stream	CIF/QCIF(1~12/15fps)	1*720P(1~25/30fps) +15*(1~15fps)/960H/D1 (1~25/30fps)
Bit Rate	96~4096Kb/s		
Record Mode	Manual, Schedule(Regular/Continuous), MD, Stop		
Record Interval	1~60 min (default: 60 min), Pre-record: 1~30 sec, Post-record: 10~300 sec		
<b>Video Detection &amp; Alarm</b>			
Trigger Events	Recording, PTZ, Tour, Alarm out, Video Push, Email, FTP, Snapshot, Buzzer & Screen tips		
Video Detection	Motion Detection, MD Zones: 396(22×18), Video Loss & Camera Blank		
Alarm Input	8 channel	8 channel	16 channel
Relay Output	3 channel		
<b>Playback &amp; Backup</b>			
Sync Playback	1/4	1/4/9	1/4/9/16
Search Mode	Time/Date, MD & Exact search (accurate to second)		
Playback Functions	Play, Pause, Stop, Rewind, Fast play, Slow play, Next file, Previous file, Next camera, Previous camera, Full screen, Repeat, Shuffle, Backup selection, Digital zoom		
Backup Mode	USB Device/Internal SATA burner/Network		
<b>Network</b>			
Ethernet	RJ-45 port (10/100M)		
Network Functions	HTTP, IPv4/IPv6, TCP/IP, UPNP, RTSP, UDP, SMTP, NTP, DHCP, DNS, PPPOE, DDNS, FTP, IP Filter, SNMP, P2P		
Max. User Access	128 users		
Smart Phone	iPhone, iPad, Android, Windows Phone		
<b>Storage</b>			
Internal HDD	2 SATA ports, up to 8TB		
<b>Auxiliary Interface</b>			
USB Interface	2 ports(1 Rear), USB2.0		
RS485	1 port, For PTZ control		
<b>General</b>			
Power Supply	DC12V/4A		
Power Consumption	15W(without HDD)		
Working Environment	-10°C ~+55°C / 10%~90%RH / 86~106kpa		
Dimension(W×D×H)	1U, 375mm×285mm×55mm		
Weight	2.35kg (without HDD)		

# DH-HCVR4216AN-S2 NEW



16CH Tribrid 720P-Lite 1U HDCVI DVR



## Features

- Support HDCVI/Analog/IP Video input
- H.264 dual-stream video compression
- HCVR4216AN-S2: All channel 720P recording
- HDMI/VGA simultaneous video output
- 16 channel synchronous playback, GRID interface & smart search
- Support Multi-brand network cameras: Dahua, Arecont Vision, AXIS, Bosch, Brickcom, Canon, CP Plus, Dynacolor, Honeywell, Panasonic, Pelco, Samsung, Sanyo, Sony, Videosec, Vivotek and etc.
- ONVIF Version 2.4 conformance
- Support 2 SATA HDDs up to 8TB, 2 USB2.0
- 3D intelligent positioning with Dahua PTZ dome camera
- Multiple network monitoring: Web viewer, CMS(DSS/Smart PSS)&Smart Phone(DMSS)

## System Connection

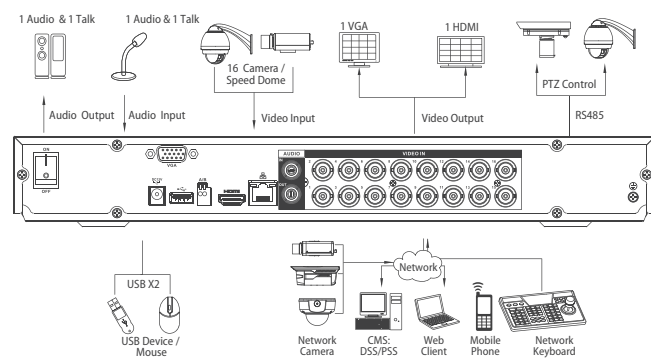

\*Takes HCVR4216AN-S2 as an example

## Technical Specifications

Model	DH-HCVR4216AN-S2	
<b>System</b>		
Main Processor	Embedded processor	
Operating System	Embedded LINUX	
<b>Video</b>		
Input	16 channel, BNC	
Standard	HDCVI	720P HDCVI Camera
	Analog	NTSC/PAL
	IP	Support 2ch 1080P/720P IP Camera
<b>Audio</b>		
Input	1 channel, RCA	
Output	1 channel, RCA	
Two-way Talk	Reuse audio input/output channel 1	
<b>Display</b>		
Interface	1 HDMI, 1 VGA	
Resolution	1920×1080, 1280×1024, 1280×720, 1024×768	
Display Split	1/4/8/9/16	
Privacy Masking	4 rectangular zones (each camera)	
OSD	Camera title, Time, Video loss, Camera lock, Motion detection, Recording	
<b>Recording</b>		
Video/Audio Compression	H.264/G.711	
Record Rate	Main stream	1*720P(1~25/30fps)+15*(1~15fps)/960H/D1 (1~25/30fps)
	Extra stream	CIF/QCIF(1~12/15fps)
Bit Rate	96~4096Kb/s	
Record Mode	Manual, Schedule(Regular(Continuous), MD), Stop	
Record Interval	1~60 min (default: 60 min), Pre-record: 1~30 sec, Post-record: 10~300 sec	
<b>Video Detection</b>		
Trigger Events	Recording, PTZ, Tour, Alarm out, Video Push, Email, FTP, Snapshot, Buzzer & Screen tips	
Video Detection	Motion Detection, MD Zones: 396(22×18), Video Loss & Camera Blank	
<b>Playback &amp; Backup</b>		
Sync Playback	1/4/9/16	
Search Mode	Time/Date, MD & Exact search (accurate to second)	
Playback Functions	Play, Pause, Stop, Rewind, Fast play, Slow play, Next file, Previous file, Next camera, Previous camera, Full screen, Repeat, Shuffle, Backup selection, Digital zoom	
Backup Mode	USB Device/Internal SATA burner/Network	
<b>Network</b>		
Ethernet	RJ-45 port (10/100M)	
Network Functions	HTTP, IPv4/IPv6, TCP/IP, UPNP, RTSP, UDP, SMTP, NTP, DHCP, DNS, PPPoE, DDNS, FTP, IP Filter, SNMP, P2P	
Max. User Access	128 users	
Smart Phone	iPhone, iPad, Android, Windows Phone	
<b>Storage</b>		
Internal HDD	2 SATA ports, up to 8TB	
<b>Auxiliary Interface</b>		
USB Interface	2 ports(1 Rear), USB2.0	
RS485	1 port, For PTZ control	
<b>General</b>		
Power Supply	DC12V/4A	
Power Consumption	15W(without HDD)	
Working Environment	-10°C ~+55°C / 10%~90%RH / 86~106kpa	
Dimension(W×D×H)	1U, 375mm×285mm×55mm	
Weight	2.35kg (without HDD)	

# DH-HCVR4104/4108/4116HE-S2 NEW



4/8/16CH Tribrid 720P-Lite Mini 1U HDCVI DVR



## Features

- Support HDCVI/Analog/IP Video input
- H.264 dual-stream video compression
- HCVR4104/4108/4116HE-S2: All channel 720P recording
- HDMI/VGA simultaneous video output
- 4/8/16 channel synchronous playback, GRID interface & smart search
- Support Multi-brand network cameras: Dahua, Arecont Vision, AXIS, Bosch, Brickcom, Canon, CP Plus, Dynacolor, Honeywell, Panasonic, Pelco, Samsung, Sanyo, Sony, Videosec, Vivotek and etc.
- ONVIF Version 2.4 conformance
- Support 1 SATA HDD up to 4TB, 2 USB2.0
- 3D intelligent positioning with Dahua PTZ dome camera
- Multiple network monitoring: Web viewer, CMS(DSS/Smart PSS)&Smart Phone(DMSS)

## System Connection

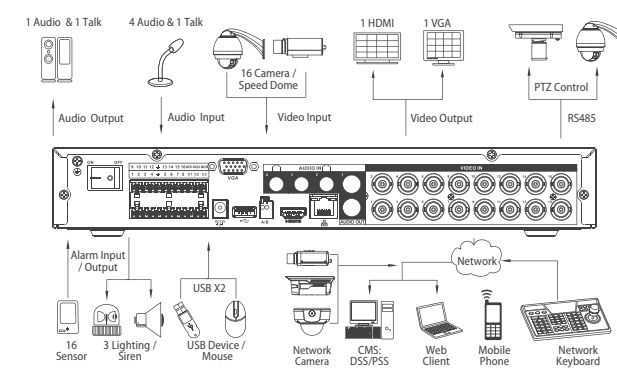

\*Takes HCVR4116HE-S2 as an example

## Technical Specifications

Model	DH-HCVR4104HE-S2	DH-HCVR4108HE-S2	DH-HCVR4116HE-S2
<b>System</b>			
Main Processor	Embedded processor		
Operating System	Embedded LINUX		
<b>Video</b>			
Input	4 channel, BNC	8 channel, BNC	16 channel, BNC
Standard	HDCVI	720P HDCVI Camera	
	Analog	NTSC/PAL	
	IP	Support 2ch 1080P/720P IP Camera	
<b>Audio</b>			
Input	4 channel, RCA		
Output	1 channel, RCA		
Two-way Talk	Reuse audio input/output channel 1		
<b>Display</b>			
Interface	1 HDMI, 1 VGA		
Resolution	1920×1080, 1280×1024, 1280×720, 1024×768		
Display Split	1/4	1/4/8/9	1/4/8/9/16
Privacy Masking	4 rectangular zones (each camera)		
OSD	Camera title, Time, Video loss, Camera lock, Motion detection, Recording		
<b>Recording</b>			
Video/Audio Compression	H.264/G.711		
Record Rate	Main stream	720P/960H/D1(1~25/30fps)+15*(1~15fps)/960H/D1 (1~25/30fps)	1*720P(1~25/30fps)+15*(1~15fps)/960H/D1 (1~25/30fps)
	Extra stream	CIF/QCIF(1~12/15fps)	15*(1~15fps)/960H/D1 (1~25/30fps)
Bit Rate	96~4096Kb/s		
Record Mode	Manual, Schedule(Regular(Continuous), MD), Stop		
Record Interval	1~60 min (default: 60 min), Pre-record: 1~30 sec, Post-record: 10~300 sec		
<b>Video Detection&amp; Alarm</b>			
Trigger Events	Recording, PTZ, Tour, Alarm out, Video Push, Email, FTP, Snapshot, Buzzer & Screen tips		
Video Detection	Motion Detection, MD Zones: 396(22×18), Video Loss & Camera Blank		
Alarm Input	4 channel	8 channel	16 channel
Relay Output	3 channel		
<b>Playback &amp; Backup</b>			
Sync Playback	1/4	1/4/9	1/4/9/16
Search Mode	Time/Date, MD & Exact search (accurate to second)		
Playback Functions	Play, Pause, Stop, Rewind, Fast play, Slow play, Next file, Previous file, Next camera, Previous camera, Full screen, Repeat, Shuffle, Backup selection, Digital zoom		
Backup Mode	USB Device/Internal SATA burner/Network		
<b>Network</b>			
Ethernet	RJ-45 port (10/100M)		
Network Functions	HTTP, IPv4/IPv6, TCP/IP, UPNP, RTSP, UDP, SMTP, NTP, DHCP, DNS, PPPoE, DDNS, FTP, IP Filter, SNMP, P2P		
Max. User Access	128 users		
Smart Phone	iPhone, iPad, Android, Windows Phone		
<b>Storage</b>			
Internal HDD	1 SATA port, up to 4TB		
<b>Auxiliary Interface</b>			
USB Interface	2 ports(1 Rear), USB2.0		
RS485	1 port, For PTZ Control		
<b>General</b>			
Power Supply	DC12V/1.5A	DC12V/2A	
Power Consumption	10W(without HDD)		
Working Environment	-10°C ~+55°C / 10%~90%RH / 86~106kpa		
Dimension(W×D×H)	Mini 1U, 325mm×255mm×55mm		
Weight	1.5kg (without HDD)		

HDCVI DVR  
HDCVI Camera  
HDCVI PTZ Camera



# DH-HCVR4104/4108/4116HS-S2 **NEW**



## 4/8/16CH Tribrid 720P-Lite Compact 1U HDCVI DVR



### Features

- Support HDCVI/Analog/IP Video input
- H.264 dual-stream video compression
- HCVR4104/4108/4116HS-S2: All channel 720P recording
- HDMI/VGA simultaneous video output
- 4/8/16 channel synchronous playback, GRID interface & smart search
- Support Multi-brand network cameras: Dahua, Arecont Vision, AXIS, Bosch, Brickcom, Canon, CP Plus, Dynacolor, Honeywell, Panasonic, Pelco, Samsung, Sanyo, Sony, Videosec, Vivotek and etc.
- ONVIF Version 2.4 conformance
- Support 1 SATA HDD up to 4TB, 2 USB2.0
- 3D intelligent positioning with Dahua PTZ dome camera
- Multiple network monitoring: Web viewer, CMS(DSS/Smart PSS)&Smart Phone(DMSS)

### System Connection

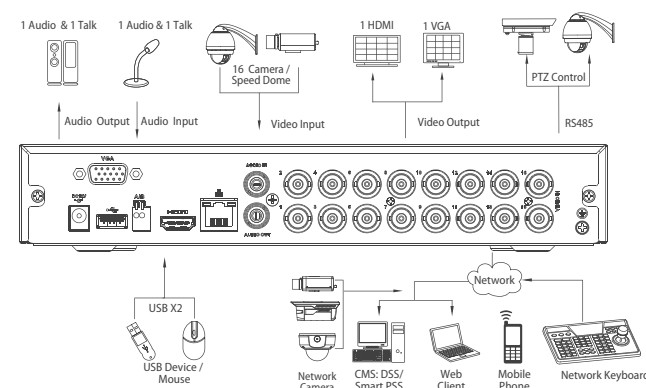

\*Takes HCVR4116HS-S2 as an example

### Technical Specifications

Model	DH-HCVR4104HS-S2	DH-HCVR4108HS-S2	DH-HCVR4116HS-S2
<b>System</b>			
Main Processor	Embedded processor		
Operating System	Embedded LINUX		
<b>Video</b>			
Input	4 channel, BNC	8 channel, BNC	16 channel, BNC
Standard	HDCVI	720P HDCVI Camera	
	Analog	NTSC/PAL	
	IP	Support 2ch 1080P/720P IP Camera	
<b>Audio</b>			
Input	1 channel, RCA		
Output	1 channel, RCA		
Two-way Talk	Reuse audio input/output channel 1		
<b>Display</b>			
Interface	1 HDMI, 1 VGA		
Resolution	1920×1080, 1280×1024, 1280×720, 1024×768		
Display Split	1/4	1/4/8/9	1/4/8/9/16
Privacy Masking	4 rectangular zones (each camera)		
OSD	Camera title, Time, Video loss, Camera lock, Motion detection, Recording		
<b>Recording</b>			
Video/Audio Compression	H.264/G.711		
Record Rate	Main stream	720P/960H/D1(1~25/30fps) +7*(1~15fps)/960H/D1 (1~25/30fps)	1*720P(1~25/30fps) +15*(1~15fps)/960H/D1 (1~25/30fps)
	Extra stream	CIF/QCIF(1~12/15fps)	
Bit Rate	96~4096Kb/s		
Record Mode	Manual, Schedule(Regular(Continuous), MD), Stop		
Record Interval	1~60 min (default: 60 min), Pre-record: 1~30 sec, Post-record: 10~300 sec		
<b>Video Detection</b>			
Trigger Events	Recording, PTZ, Tour, Video Push, Email, FTP, Snapshot, Buzzer & Screen tips		
Video Detection	Motion Detection, MD Zones: 396(22×18), Video Loss & Camera Blank		
<b>Playback &amp; Backup</b>			
Sync Playback	1/4	1/4/9	1/4/9/16
Search Mode	Time/Date, MD & Exact search (accurate to second)		
Playback Functions	Play, Pause, Stop, Rewind, Fast play, Slow play, Next file, Previous file, Next camera, Previous camera, Full screen, Repeat, Shuffle, Backup selection, Digital zoom		
Backup Mode	USB Device/Internal SATA burner/Network		
<b>Network</b>			
Ethernet	RJ-45 port (10/100M)		
Network Functions	HTTP, IPv4/IPv6, TCP/IP, UPNP, RTSP, UDP, SMTP, NTP, DHCP, DNS, PPPoE, DDNS, FTP, IP Filter, SNMP, P2P		
Max. User Access	128 users		
Smart Phone	iPhone, iPad, Android, Windows Phone		
<b>Storage</b>			
Internal HDD	1 SATA port, up to 4TB		
<b>Auxiliary Interface</b>			
USB Interface	2 ports(1 Rear), USB2.0		
RS485	1 port, For PTZ Control		
<b>General</b>			
Power Supply	DC12V/1.5A	DC12V/2A	
Power Consumption	10W(without HDD)		
Working Environment	-10°C ~ +55°C / 10%~90%RH / 86~106kpa		
Dimension(W×D×H)	Compact 1U, 260mm×220mm×40mm		
Weight	0.75kg (without HDD)		

# DH-HCVR4104/4108C-S2 **NEW**



## 4/8CH Tribrid 720P-Lite Smart 1U HDCVI DVR



### Features

- Support HDCVI/Analog/IP Video input
- H.264 dual-stream video compression
- HCVR4104/4108C-S2: All channel 720P recording
- HDMI/VGA simultaneous video output
- 4/8 channel synchronous playback, GRID interface & smart search
- Support Multi-brand network cameras: Dahua, Arecont Vision, AXIS, Bosch, Brickcom, Canon, CP Plus, Dynacolor, Honeywell, Panasonic, Pelco, Samsung, Sanyo, Sony, Videosec, Vivotek and etc.
- ONVIF Version 2.4 conformance
- Support 1 SATA HDD up to 4TB, 2 USB2.0
- 3D intelligent positioning with Dahua PTZ dome camera
- Multiple network monitoring: Web viewer, CMS(DSS/Smart PSS)&Smart Phone(DMSS)

### System Connection

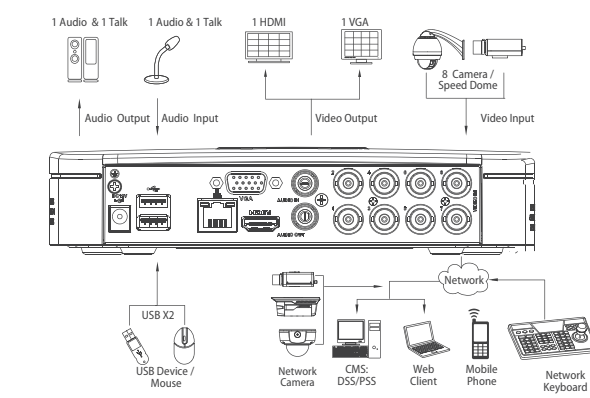

\*Takes HCVR4108C-S2 as an example

### Technical Specifications

Model	DH-HCVR4104C-S2	DH-HCVR4108C-S2
<b>System</b>		
Main Processor	Embedded processor	
Operating System	Embedded LINUX	
<b>Video</b>		
Input	4 channel, BNC	8 channel, BNC
Standard	HDCVI	720P HDCVI Camera
	Analog	NTSC/PAL
	IP	Support 2ch 1080P/720P IP Camera
<b>Audio</b>		
Input	1 channel, RCA	
Output	1 channel, RCA	
Two-way Talk	Reuse audio input/output channel 1	
<b>Display</b>		
Interface	1 HDMI, 1 VGA	
Resolution	1920×1080, 1280×1024, 1280×720, 1024×768	
Display Split	1/4	1/4/8/9
Privacy Masking	4 rectangular zones (each camera)	
OSD	Camera title, Time, Video loss, Camera lock, Motion detection, Recording	
<b>Recording</b>		
Video/Audio Compression	H.264/G.711	
Record Rate	Main stream	720P/960H/D1(1~25/30fps) +7*(1~15fps)/960H/D1 (1~25/30fps)
	Extra stream	CIF/QCIF(1~12/15fps)
Bit Rate	80~4096Kb/s	
Record Mode	Manual, Schedule(Regular(Continuous), MD), Stop	
Record Interval	1~60 min (default: 60 min), Pre-record: 1~30 sec, Post-record: 10~300 sec	
<b>Video Detection</b>		
Trigger Events	Recording, PTZ, Tour, Video Push, Email, FTP, Snapshot, Buzzer & Screen tips	
Video Detection	Motion Detection, MD Zones: 396(22×18), Video Loss & Camera Blank	
<b>Playback &amp; Backup</b>		
Sync Playback	1/4	1/4/9
Search Mode	Time/Date, MD & Exact search (accurate to second)	
Playback Functions	Play, Pause, Stop, Rewind, Fast play, Slow play, Next file, Previous file, Next camera, Previous camera, Full screen, Repeat, Shuffle, Backup selection, Digital zoom	
Backup Mode	USB Device/Internal SATA burner/Network	
<b>Network</b>		
Ethernet	RJ-45 port (10/100M)	
Network Functions	HTTP, IPv4/IPv6, TCP/IP, UPNP, RTSP, UDP, SMTP, NTP, DHCP, DNS, PPPoE, DDNS, FTP, IP Filter, SNMP, P2P	
Max. User Access	128 users	
Smart Phone	iPhone, iPad, Android, Windows Phone	
<b>Storage</b>		
Internal HDD	1 SATA port, up to 4TB	
<b>Auxiliary Interface</b>		
USB Interface	2 ports(2 Rear), USB2.0	
<b>General</b>		
Power Supply	DC12V/1.5A	DC12V/2A
Power Consumption	10W(without HDD)	
Working Environment	-10°C ~ +55°C / 10%~90%RH / 86~106kpa	
Dimension(W×D×H)	Smart 1U, 205mm×205mm×40mm	
Weight	0.5kg (without HDD)	

HDCVI DVR

HDCVI Camera

HDCVI PTZ Camera

# DH-iHCVR5104/5108HE-F

## 4/8CH 720P Mini 1U Face Detection iHCVR



### Features

- Support 1ch face detection, instant playback and face index playback
- Up to 4/8 cameras input
- H.264 dual-stream video compression
- iHCVR5104/5108HE-F: All channel 720P realtime recording
- HDMI/VGA simultaneous video output
- 4/8 channel synchronous realtime playback, GRID interface & smart search
- Support Multi-brand network cameras: Dahua, Arecont Vision, AXIS, Bosch, Brickcom, Canon, CP Plus, Dynacolor, Honeywell, Panasonic, Pelco, Samsung, Sanyo, Sony, Videosec, Vivotek and etc.
- ONVIF Version 2.3 conformance
- Support 1 SATA HDD up to 4TB, 2 USB2.0
- 3D intelligent positioning with Dahua PTZ dome camera
- Multiple network monitoring: Web viewer, CMS(DSS/Smart PSS)&Smart Phone(DMSS)

### System Connection

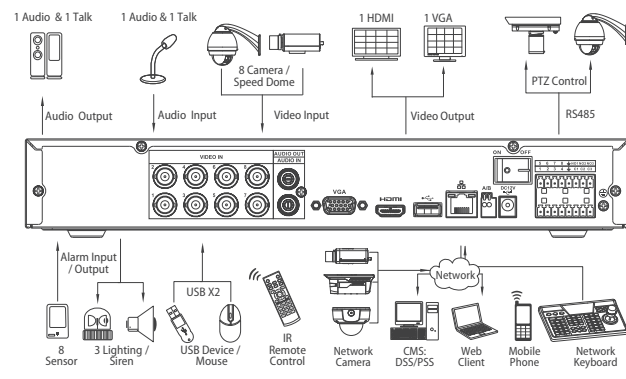

### Technical Specifications

Model	DH-iHCVR5104HE-F	DH-iHCVR5108HE-F
<b>System</b>		
Main Processor	Embedded processor	
Operating System	Embedded LINUX	
<b>Video</b>		
Input	4 channel, BNC	8 channel, BNC
Standard	HDCVI 1080P/720P HDCVI Camera	
IP	Support 2ch 1080P/720P IP Camera	
<b>Audio</b>		
Input	1 channel, RCA	
Output	1 channel, RCA	
Two-way Talk	Reuse audio input/output channel 1	
<b>Display</b>		
Interface	1 HDMI, 1 VGA	
Resolution	1920×1080, 1280×1024, 1280×720, 1024×768	
Display Split	1/4	1/4/8/9
Privacy Masking	4 rectangular zones (each camera)	
OSD	Camera title, Time, Video loss, Camera lock, Motion detection, Recording	
<b>Recording</b>		
Video/Audio Compression	H.264/G.711	
Resolution	1080P(1920×1280)/720P(1280×720)/960H(960×576/960×480)/D1/4CIF(704×576/704×480) / CIF(352×288/352×240) / QCIF(176×144/176×120)	
Record Rate	Main stream 720P/960H/D1/HD1/2CIF/CIF(1~25/30fps)	Extra stream CIF/QCIF(1~25/30fps), D1(1~12/15fps)
Bit Rate	48~4096Kb/s	
Record Mode	Manual, Schedule(Regular/Continuous), MD, Stop	
Record Interval	1~60 min (default: 60 min), Pre-record: 1~30 sec, Post-record: 10~300 sec	
<b>Video Detection &amp; Alarm</b>		
Trigger Events	Recording, PTZ, Tour, Alarm out, Video Push, Email, FTP, Spot, Snapshot, Buzzer & Screen tips	
Video Detection	Motion Detection, MD Zones: 396(22×18), Video Loss & Camera Blank	
Alarm Input	4 channel	8 channel
Relay Output	3 channel	
<b>Playback &amp; Backup</b>		
Sync Playback	1/4	1/4/9
Search Mode	Time/Date, MD & Exact search (accurate to second)	
Playback Functions	Play, Pause, Stop, Rewind, Fast play, Slow play, Next file, Previous file, Next camera, Previous camera, Full screen, Repeat, Shuffle, Backup selection, Digital zoom	
Backup Mode	USB Device/Internal SATA burner/Network	
<b>Network</b>		
Ethernet	RJ-45 port (10/100M)	
Network Functions	HTTP, IPv4/IPv6, TCP/IP, UPNP, RTSP, UDP, SMTP, NTP, DHCP, DNS, PPPoE, DDNS, FTP, IP Filter, SNMP, P2P	
Max. User Access	128 users	
Smart Phone	iPhone, iPad, Android, Windows Phone	
<b>Storage</b>		
Internal HDD	1 SATA port, up to 4TB	
<b>Auxiliary Interface</b>		
USB Interface	2 ports(1 Rear), USB2.0	
RS485	1 port, For PTZ Control	
<b>General</b>		
Power Supply	DC12V/2A	
Power Consumption	10W(without HDD)	
Working Environment	-10°C ~+55°C / 10%~90%RH / 86~106kpa	
Dimension(W×D×H)	Mini 1U, 325mm×255mm×55mm	
Weight	1.5kg (without HDD)	

# DH-iHCVR5104/5108H-F

## 4/8CH 720P Mini 1U Face Detection iHCVR



### Features

- Support 1ch face detection, instant playback and face index playback
- Up to 4/8 cameras inputs
- H.264 dual-stream video compression
- iHCVR5104/5108H-F: All channel 720P realtime recording
- HDMI/VGA simultaneous video output
- 4/8 channel synchronous realtime playback, GRID interface & smart search
- Support Multi-brand network cameras: Dahua, Arecont Vision, AXIS, Bosch, Brickcom, Canon, CP Plus, Dynacolor, Honeywell, Panasonic, Pelco, Samsung, Sanyo, Sony, Videosec, Vivotek and etc.
- ONVIF Version 2.3 conformance
- Support 1 SATA HDD up to 4TB, 2 USB2.0
- 3D intelligent positioning with Dahua PTZ dome camera
- Multiple network monitoring: Web viewer, CMS(DSS/Smart PSS)&Smart Phone(DMSS)

### System Connection

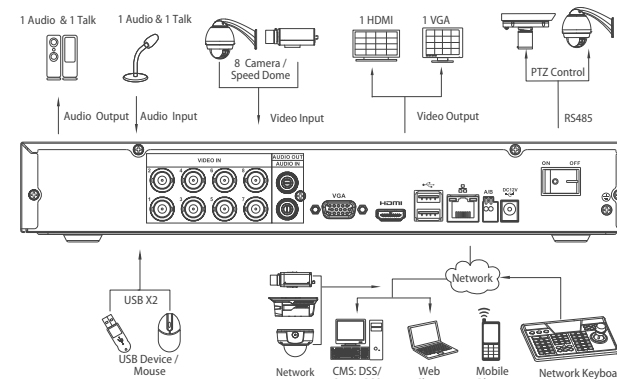

### Technical Specifications

Model	DH-iHCVR5104H-F	DH-iHCVR5108H-F
<b>System</b>		
Main Processor	Embedded processor	
Operating System	Embedded LINUX	
<b>Video</b>		
Input	4 channel, BNC	8 channel, BNC
Standard	HDCVI 1080P/720P HDCVI Camera	
IP	Support 2ch 1080P/720P IP Camera	
<b>Audio</b>		
Input	1 channel, RCA	
Output	1 channel, RCA	
Two-way Talk	Reuse audio input/output channel 1	
<b>Display</b>		
Interface	1 HDMI, 1 VGA	
Resolution	1920×1080, 1280×1024, 1280×720, 1024×768	
Display Split	1/4	1/4/8
Privacy Masking	4 rectangular zones (each camera)	
OSD	Camera title, Time, Video loss, Camera lock, Motion detection, Recording	
<b>Recording</b>		
Video/Audio Compression	H.264/G.711	
Resolution	1080P(1920×1080)/720P(1280×720)/960H(960×576/960×480)/D1/4CIF(704×576/704×480) / CIF(352×288/352×240) / QCIF(176×144/176×120)	
Record Rate	Main stream 720P/960H/D1/HD1/2CIF/CIF(1~25/30fps)	Extra stream CIF/QCIF(1~25/30fps), D1(1~12/15fps)
Bit Rate	48~4096Kb/s	
Record Mode	Manual, Schedule(Regular/Continuous), MD, Stop	
Record Interval	1~60 min (default: 60 min), Pre-record: 1~30 sec, Post-record: 10~300 sec	
<b>Video Detection</b>		
Trigger Events	Recording, PTZ, Tour, Video Push, Email, FTP, Spot, Snapshot, Buzzer & Screen tips	
Video Detection	Motion Detection, MD Zones: 396(22×18), Video Loss & Camera Blank	
<b>Playback &amp; Backup</b>		
Sync Playback	1/4	1/4/9
Search Mode	Time/Date, MD & Exact search (accurate to second)	
Playback Functions	Play, Pause, Stop, Rewind, Fast play, Slow play, Next file, Previous file, Next camera, Previous camera, Full screen, Repeat, Shuffle, Backup selection, Digital zoom	
Backup Mode	USB Device/Internal SATA burner/Network	
<b>Network</b>		
Ethernet	RJ-45 port (10/100M)	
Network Functions	HTTP, IPv4/IPv6, TCP/IP, UPNP, RTSP, UDP, SMTP, NTP, DHCP, DNS, PPPoE, DDNS, FTP, IP Filter, SNMP, P2P	
Max. User Access	128 users	
Smart Phone	iPhone, iPad, Android, Windows Phone	
<b>Storage</b>		
Internal HDD	1 SATA port, up to 4TB	
<b>Auxiliary Interface</b>		
USB Interface	2 ports(1 Rear), USB2.0	
RS485	1 port, For PTZ Control	
<b>General</b>		
Power Supply	DC12V/2A	
Power Consumption	10W(without HDD)	
Working Environment	-10°C ~+55°C / 10%~90%RH / 86~106kpa	
Dimension(W×D×H)	Mini 1U, 325mm×255mm×55mm	
Weight	1.5kg (without HDD)	

HDCVI DVR

HDCVI Camera

HDCVI PTZ Camera

# DH-MCVR5104 NEW



## 4 Channel Mobile HDCVI DVR



### Features

- Support HDCVI/Analog Video input
- H.264 dual-stream video compression
- Support 2 channel 1080P+2 channel 720P realtime recording
- VGA/TV simultaneous video output
- Support 1 SATA HDD, 2 USB2.0
- Aviation connectors adopted
- Multiple network monitoring: Web viewer, CMS(DSS/PSS) & DMSS

### System Connection

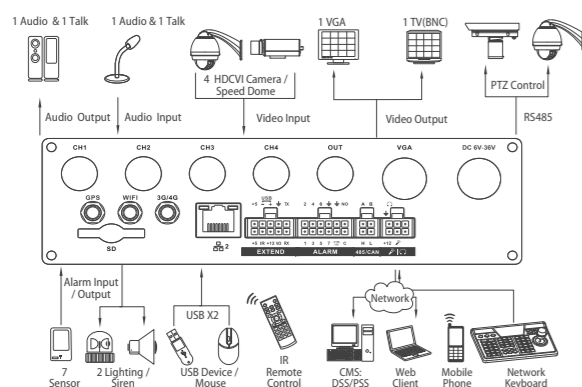

### Technical Specifications

<b>Model</b>	<b>MCVR5104</b>
<b>System</b>	
Main Processor	Embedded microprocessor
Operating System	Embedded LINUX
<b>Video</b>	
Input	4 channel
Standard	Analog NTSC(525Line), PAL(625Line) HDCVI 720P/1080P HDCVI Camera
<b>Audio</b>	
Input	4 channel
Output	1 channel
Two-way Talk	1 channel Input, 1 channel Output
<b>Display</b>	
Interface	1VGA, 2TV
Resolution	800×600
Display Split	1/4
Privacy Masking	4 rectangular zones (each camera)
OSD	Camera title, Time, Video loss, Camera lock, Motion detection, Recording
<b>Recording</b>	
Video/Audio Compression	H.264 / G.711
Record Rate	Main stream 2ch@1080P+2ch@720P(1~25/30fps) Sub stream D1(1~6/8fps)/CIF(1~25/30fps)
Bit Rate	48~8192Kb/s
Record Mode	Manual, Schedule(Regular(Continuous), MD, Alarm), Stop
Record Interval	1~120 min (default: 60 min), Pre-record: 1~30 sec, Post-record: 10~300 sec
<b>Video Detection &amp; Alarm</b>	
Trigger Events	Recording, PTZ, Tour, Alarm, Email, FTP, Buzzer & Screen tips
Video Detection	Motion Detection, MD Zones: 396(22×18), Video Loss & Camera Blank
Alarm Input	7 channel
Relay Output	2 channel
<b>Playback &amp; Backup</b>	
Playback	1
Search Mode	Time/Date, Alarm, Motion Detection & Exact search (accurate to second)
Playback Functions	Play, Pause, Stop, Rewind, Fast play, Slow play, Next file, Previous file, Next camera, Previous camera, Full screen, Repeat, Shuffle, Backup selection, Digital zoom
Backup Mode	USB Device / Network
<b>Network</b>	
Ethernet	RJ-45 port (10/100M)
Wireless Network	Built-in 3G/ Wi-Fi module(optional)
GPS	Built-in high accurate GPS module(optional)
Network Functions	TCP/IP, UDP, DHCP, DDNS, FTP, Email, Alarm Server
Max. User Access	10 users
Smart Phone	iPhone, iPad, Android, Windows Phone
<b>Storage</b>	
Internal HDD	1 SATA port
Memory Slot	1 SD card
<b>Auxiliary Interface</b>	
USB	2 ports (1 Rear), USB2.0
RS232	1 port, For PC communication & Keyboard
RS485	1 port, For PTZ control
CAN	Support
Heater	Optional
<b>General</b>	
Power Supply	6V~36V
Power Consumption	<15W(with HDD)
Working Environment	-10°C ~+60°C / 10%~95%RH / 86~106kpa
Dimension(W×D×H)	178mm×220mm×50mm
Weight	2.1KG(with HDD)
Vibration-proof	5Hz~200Hz: X / Y / Z each direction 5.5 hours 5Hz~5.5Hz: Vibration amplitude 12.7mm 5.5Hz~200Hz: 15m/s <sup>2</sup>

# HDCVI CAMERA



# DH-HAC-HF3220E NEW

## 2.4Megapixel 1080P HDCVI Box Camera



### Features

- 1/2.8" 2.4Megapixel CMOS
- 25/30@1080P, 25/30/50/60fps@720P
- High speed, long distance real-time transmission
- HD and standard definition switchable
- OSD Menu, control over coaxial cable
- DWDR, Day/Night(ICR), AWB, AGC, BLC, 3D-DNR, Auto Iris
- AC24V/DC12V

### Dimensions (mm)

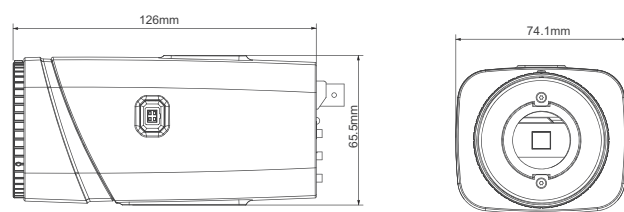

### Accessories (optional)



# DH-HAC-HFW3220E-Z(H)

## 2.4Megapixel 1080P Water-proof HDCVI IR-Bullet Camera



### Features

- 1/2.8" 2.4Megapixel CMOS
- 25/30@1080P, 25/30/50/60fps@720P
- High speed, long distance real-time transmission
- HD and standard definition switchable
- OSD Menu, control over coaxial cable
- DWDR, Day/Night(ICR), AWB, AGC, BLC, 3D-DNR
- Audio, Alarm, Heater(optional)
- 2.7~12mm motorized lens, Auto Iris
- Max. IR LEDs length 50m, Smart IR
- IP67, AC24V/DC12V

### Dimensions(mm)

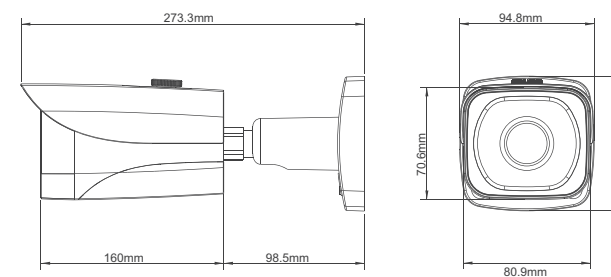

### Accessories (optional)



### Technical Specifications

Model	DH-HAC-HF3220EP	DH-HAC-HF3220EN
<b>Camera</b>		
Image Sensor	1/2.8" 2.4Megapixel CMOS	
Effective Pixels	1984(H)×1225(V)	
Electronic Shutter	1/3s~1/100,000s	
Video Frame Rate	25/30/50/60fps@720P; 25/30fps@1080P	
Synchronization	Internal	
Min. Illumination	0.05Lux@F1.2(AGC ON)	
Video Output	1-channel BNC HDCVI high definition video output / CVBS standard definition video output (Can switch) Tester out (1-channel BNC HDCVI high definition video output / CVBS standard definition video output)	
<b>Camera Features</b>		
Day/Night	Auto(ICR) / Color / B/W	
Noise Reduction	2D/3D	
OSD Menu	Support	
<b>Lens</b>		
Focal length	Manual/Auto Iris	
Mount Type	C/CS	
<b>Auxiliary Interface</b>		
RS485	1	
Alarm	1 channel in/out	
Audio	1 channel in	
<b>General</b>		
Power Supply	AC24V±10% / DC12V±10%	
Power Consumption	Max 6W	
Working Environment	-30°C~+60°C / Less than 95%RH (no condensation)	
Transmission Distance	Over 500m via 75-3 coaxial cable	
Dimensions(W×D×H)	126mm×74.1mm×65.5mm	
Weight	0.65kg	
Material	Metal	

### Technical Specifications

Model	DH-HAC-HFW3220EP-Z(H)	DH-HAC-HFW3220EN-Z(H)
<b>Camera</b>		
Image Sensor	1/2.8" 2.4Megapixel CMOS	
Effective Pixels	1984(H)×1225(V)	
Electronic Shutter	1/3s~1/100,000s	
Video Frame Rate	25/30/50/60fps@720P; 25/30fps@1080P	
Synchronization	Internal	
Min. Illumination	0.05Lux@F1.2(AGC ON), 0Lux IR on	
Video Output	1-channel BNC HDCVI high definition video output / CVBS standard definition video output (Can switch) Tester out (1-channel BNC HDCVI high definition video output / CVBS standard definition video output)	
<b>Camera Features</b>		
Max. IR LEDs Length	50m, Smart IR	
Day/Night	Auto(ICR) / Color / B/W	
Noise Reduction	2D/3D	
OSD Menu	Support	
<b>Lens</b>		
Focal Length	2.7~12mm	
Angle of View	H: 105.5°~32.9°	
Lens Type	Motorized / Auto Iris	
Mount Type	Φ14	
<b>Auxiliary Functions</b>		
Alarm	1 channel in/out	
Audio	1 channel in	
Heater	Optional	
<b>General</b>		
Power Supply	AC24V±10% / DC12V±10%	
Power Consumption	Max 7.5W Max 13W (HFW3220E-ZH)	
Working Environment	-30°C~+60°C / Less than 95%RH (no condensation) -40°C~+60°C / Less than 95%RH (no condensation) (HFW3220E-ZH)	
Transmission Distance	Over 500m via 75-3 coaxial cable	
Ingress Protection	IP67	
Dimensions(W×D×H)	273.3mm×94.8mm×94.8mm	
Weight	1.2kg	
Material	Metal	

# DH-HAC-HDBW3220E-Z(H)

2.4Megapixel 1080P Vandal-proof IR HDCVI Dome Camera



## Technical Specifications

Model	DH-HAC-HDBW3220EP-Z(H)	DH-HAC-HDBW3220EN-Z(H)
<b>Camera</b>		
Image Sensor	1/2.8" 2.4Megapixel CMOS	
Effective Pixels	1984(H)×1225(V)	
Electronic Shutter	1/3s~1/100,000s	
Video Frame Rate	25/30/50/60fps@720P; 25/30fps@1080P	
Synchronization	Internal	
Min. Illumination	0.05Lux@F1.2(AGC ON), 0Lux IR on	
Video Output	1-channel BNC HDCVI high definition video output / CVBS standard definition video output (Can switch) Tester out (1-channel BNC HDCVI high definition video output / CVBS standard definition video output)	
<b>Camera Features</b>		
Day/Night	50m, Smart IR	
Backlight Compensation	Auto(ICR) / Color / B/W	
Noise Reduction	2D/3D	
OSD Menu	Support	
<b>Lens</b>		
Focal Length	2.7~12mm	
Angle of View	H: 105.5°~32.9°	
Lens Type	Motorized / Auto Iris	
Mount Type	Φ14	
<b>Auxiliary Functions</b>		
Alarm	1 channel in/out	
Audio	1 channel in	
Heater	Optional	
<b>General</b>		
Power Supply	AC24V±10% / DC12V±10%	
Power Consumption	Max 8.4W Max 9.6W (HDBW3220E-ZH)	
Working Environment	-30°C~+60°C / Less than 95%RH (no condensation) -40°C~+60°C / Less than 95%RH (no condensation) (HDBW3220E-ZH)	
Transmission Distance	Over 500m via 75-3 coaxial cable	
Ingress Protection	IP67 & IK10	
Dimensions	Φ150mm×119.1mm	
Weight	0.8kg	
Material	Metal	



## Features

- 1/2.8" 2.4Megapixel CMOS
- 25/30@1080P, 25/30/50/60fps@720P
- High speed, long distance real-time transmission
- HD and standard definition switchable
- OSD Menu, control over coaxial cable
- DWDR, Day/Night(ICR), AWB, AGC, BLC, 3D-DNR
- Audio, Alarm, Heater(optional)
- 2.7~12mm motorized lens, Auto Iris
- Max. IR LEDs length 50m, Smart IR
- IP67, IK10, AC24V/DC12V

## Dimensions (mm)

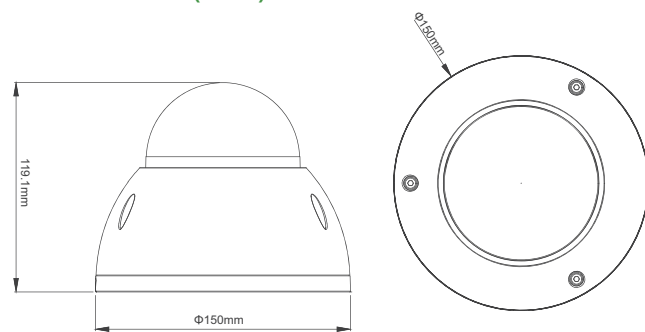

## Accessories (optional)



# DH-HAC-HFW2220R-Z(-IRE6)

2.4Megapixel 1080P Water-proof HDCVI IR-Bullet Camera



## Technical Specifications

Model	DH-HAC-HFW2220RP-Z	DH-HAC-HFW2220RN-Z
<b>Camera</b>		
Image Sensor	1/2.8" 2.4Megapixel CMOS	
Effective Pixels	1984(H)×1225(V)	
Electronic Shutter	1/3s~1/100,000s	
Video Frame Rate	25/30/50/60fps@720P; 25/30fps@1080P	
Synchronization	Internal	
Mini. Illumination	0.05Lux@F1.2(AGC ON), 0Lux IR on	
Video Output	1-channel BNC HDCVI high definition video output/ CVBS standard definition video output (Can switch)	
<b>Camera Features</b>		
Max. IR LEDs Length	30m (60m optional), Smart IR	
Day/Night	Auto(ICR) / Color / B/W	
Noise Reduction	2D/3D	
OSD Menu	Support	
<b>Lens</b>		
Focal Length	2.7~12mm	
Angle of View	H: 105.5°~32.9°	
Lens Type	Motorized / Fixed Iris	
Mount Type	Φ14	
<b>General</b>		
Power Supply	DC12V±10%	
Power Consumption	Max 7.5W(30m IR) / 11W(60m IR)	
Working Environment	-30°C~+60°C / Less than 95%RH (no condensation)	
Transmission Distance	Over 500m via 75-3 coaxial cable	
Ingress Protection	IP67	
Dimensions(W×D×H)	213mm×80mm×72mm	
Weight	0.55kg	
Material	Metal	



## Features

- 1/2.8" 2.4Megapixel CMOS
- 25/30@1080P, 25/30/50/60fps@720P
- High speed, long distance real-time transmission
- HD and standard definition switchable
- OSD Menu, control over coaxial cable
- DWDR, Day/Night(ICR), AWB, AGC, BLC, 3D-DNR
- 2.7~12mm motorized lens
- Max. IR LEDs length 30m (60m optional), Smart IR
- IP67, DC12V

## Dimensions (mm)

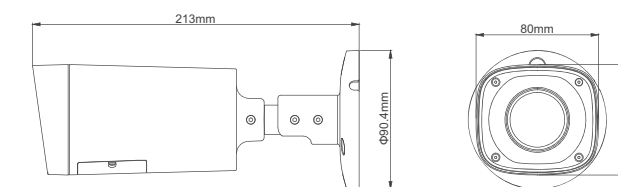

## Accessories (optional)



# DH-HAC-HFW2220R-VF(-IRE6)

2.4Megapixel 1080P Water-proof HDCVI IR-Bullet Camera



## Features

- 1/2.8" 2.4Megapixel CMOS
- 25/30@1080P, 25/30/50/60fps@720P
- High speed, long distance real-time transmission
- HD and standard definition switchable
- OSD Menu, control over coaxial cable
- DWDR, Day/Night(ICR), AWB, AGC, BLC, 3D-DNR
- 2.7~12mm vari-focal lens
- Max. IR LEDs length 30m (60m optional), Smart IR
- IP67 DC12V

## Dimensions(mm)

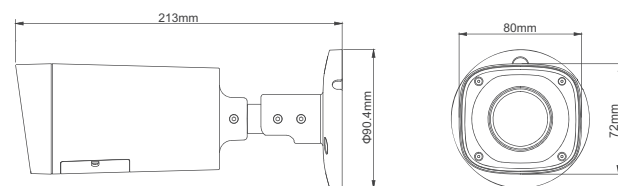

## Accessories (optional)



PFA122 PFA152

## Technical Specifications

Model	DH-HAC-HFW2220RP-VF	DH-HAC-HFW2220RN-VF
<b>Camera</b>		
Image Sensor	1/2.8" 2.4Megapixel CMOS	
Effective Pixels	1984(H)×1225(V)	
Electronic Shutter	1/3s~1/100,000s	
Video Frame Rate	25/30/50/60fps@720P; 25/30fps@1080P	
Synchronization	Internal	
Mini. Illumination	0.05Lux@F1.2(AGC ON), 0Lux IR on	
Video Output	1-channel BNC HDCVI high definition video output/ CVBS standard definition video output (Can switch)	
<b>Camera Features</b>		
Max. IR LEDs Length	30m (60m optional), Smart IR	
Day/Night	Auto(ICR) / Color / B/W	
Noise Reduction	2D/3D	
OSD Menu	Support	
<b>Lens</b>		
Focal Length	2.7~12mm	
Angle of View	H: 105.5°~32.9°	
Lens Type	Manual / Fixed Iris	
Mount Type	Ø14	
<b>General</b>		
Power Supply	DC12V±10%	
Power Consumption	Max 4W(30m IR) / 8.5W(60m IR)	
Working Environment	-30°C~+60°C / Less than 95%RH (no condensation)	
Transmission Distance	Over 500m via 75-3 coaxial cable	
Ingress Protection	IP67	
Dimensions(W×D×H)	213mm×80mm×72mm	
Weight	0.55kg	
Material	Metal	

# DH-HAC-HDBW2220R-Z

2.4Megapixel 1080P Vandal-proof IR HDCVI Dome Camera



## Features

- 1/2.8" 2.4Megapixel CMOS
- 25/30@1080P, 25/30/50/60fps@720P
- High speed, long distance real-time transmission
- HD and standard definition switchable
- OSD Menu, control over coaxial cable
- DWDR, Day/Night(ICR), AWB, AGC, BLC, 3D-DNR
- 2.7~12mm motorized lens
- Max. IR LEDs length 30m, Smart IR
- IP67, IK10, DC12V

## Dimensions (mm)

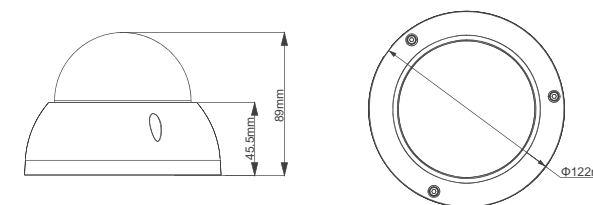

## Accessories (optional)



PFB203W PFA137 PFA152

## Technical Specifications

Model	DH-HAC-HDBW2220RP-Z	DH-HAC-HDBW2220RN-Z
<b>Camera</b>		
Image Sensor	1/2.8" 2.4Megapixel CMOS	
Effective Pixels	1984(H)×1225(V)	
Electronic Shutter	1/3s~1/100,000s	
Video Frame Rate	25/30/50/60fps@720P; 25/30fps@1080P	
Synchronization	Internal	
Mini. Illumination	0.05Lux@F1.2(AGC ON), 0Lux IR on	
Video Output	1-channel BNC HDCVI high definition video output/ CVBS standard definition video output (Can switch)	
<b>Camera Features</b>		
Max. IR LEDs Length	30m, Smart IR	
Day/Night	Auto(ICR) / Color / B/W	
Noise Reduction	2D/3D	
OSD Menu	Support	
<b>Lens</b>		
Focal Length	2.7~12mm	
Angle of View	H: 105.5°~32.9°	
Lens Type	Motorized / Fixed Iris	
Mount Type	Ø14	
<b>General</b>		
Power Supply	DC12V±10%	
Power Consumption	Max 8.6W	
Working Environment	-30°C~+60°C / Less than 95%RH (no condensation)	
Transmission Distance	Over 500m via 75-3 coaxial cable	
Ingress Protection	IP67 & IK10	
Dimensions(W×D×H)	Ø122mm×89mm	
Weight	0.45kg	
Material	Metal	

# DH-HAC-HDBW2220R-VF

2.4Megapixel 1080P Vandal-proof IR HDCVI Dome Camera



## Technical Specifications

Model	DH-HAC-HDBW2220RP-VF	DH-HAC-HDBW2220RN-VF
<b>Camera</b>		
Image Sensor	1/2.8" 2.4Megapixel CMOS	
Effective Pixels	1984(H)×1225(V)	
Electronic Shutter	1/3s~1/100,000s	
Video Frame Rate	25/30/50/60fps@720P; 25/30fps@1080P	
Synchronization	Internal	
Min. Illumination	0.05Lux@F1.2(AGC ON), 0Lux IR on	
Video Output	1-channel BNC HDCVI high definition video output/ CVBS standard definition video output (Can switch)	
<b>Camera Features</b>		
Max. IR LEDs Length	30m, Smart IR	
Day/Night	Auto(ICR) / Color / B/W	
Noise Reduction	2D/3D	
OSD Menu	Support	
<b>Lens</b>		
Focal Length	2.7~12mm	
Angle of View	H: 105.5°~32.9°	
Lens Type	Manual / Fixed Iris	
Mount Type	Φ14	
<b>General</b>		
Power Supply	DC12V±10%	
Power Consumption	Max 5.8W	
Working Environment	-30°C~+60°C / Less than 95%RH (no condensation)	
Transmission Distance	Over 500m via 75-3 coaxial cable	
Ingress Protection	IP67 & IK10	
Dimensions	Φ122mm×89mm	
Weight	0.45kg	
Material	Metal	



## Features

- 1/2.8" 2.4Megapixel CMOS
- 25/30@1080P, 25/30/50/60fps@720P
- High speed, long distance real-time transmission
- HD and standard definition switchable
- OSD Menu, control over coaxial cable
- DWDR, Day/Night(ICR), AWB, AGC, BLC, 3D-DNR
- 2.7~12mm vari-focal lens
- Max. IR LEDs length 30m, Smart IR
- IP67, IK10, DC12V

## Dimensions(mm)

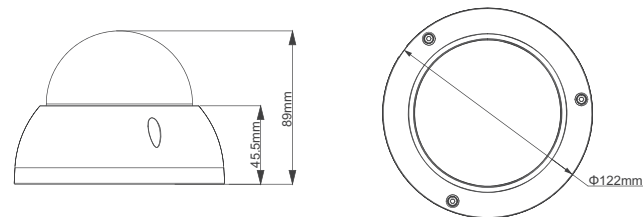

## Accessories (optional)



# DH-HAC-HDW2220E-Z NEW

2.4Megapixel 1080P Water-proof IR HDCVI Dome Camera



## Technical Specifications

Model	DH-HAC-HDW2220EP-Z	DH-HAC-HDW2220EN-Z
<b>Camera</b>		
Image Sensor	1/2.8" 2.4Megapixel CMOS	
Effective Pixels	1984(H)×1225(V)	
Electronic Shutter	1/3s~1/100,000s	
Video Frame Rate	25/30/50/60fps@720P; 25/30fps@1080P	
Synchronization	Internal	
Min. Illumination	0.05Lux@F1.2(AGC ON), 0Lux IR on	
Video Output	1-channel BNC HDCVI high definition video output/ CVBS standard definition video output (Can switch)	
<b>Camera Features</b>		
Max. IR LEDs Length	60m, Smart IR	
Day/Night	Auto(ICR) / Color / B/W	
Noise Reduction	2D/3D	
OSD Menu	Support	
<b>Lens</b>		
Focal Length	2.7~12mm	
Angle of View	H: 105.5°~32.9°	
Lens Type	Manual / Fixed Iris	
Mount Type	Φ14	
<b>General</b>		
Power Supply	DC12V±10%	
Power Consumption	Max 6.8W	
Working Environment	-30°C~+60°C / Less than 95%RH (no condensation)	
Transmission Distance	Over 500m via 75-3 coaxial cable	
Ingress Protection	IP67	
Dimensions	Φ122mm×102mm	
Weight	0.55kg	
Material	Metal	



## Features

- 1/2.8" 2.4Megapixel CMOS
- 25/30@1080P, 25/30/50/60fps@720P
- High speed, long distance real-time transmission
- HD and standard definition switchable
- OSD Menu, control over coaxial cable
- DWDR, Day/Night(ICR), AWB, AGC, BLC, 3D-DNR
- 2.7~12mm motorized lens
- Max. IR LEDs length 60m, Smart IR
- IP67, DC12V

## Dimensions (mm)

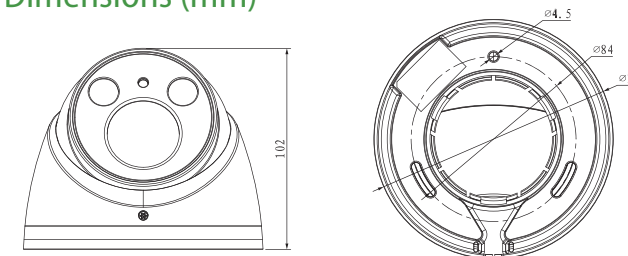

## Accessories (optional)



# DH-HAC-HDW2220R-VF



2.4Megapixel 1080P Water-proof IR HDCVI Dome Camera



## Technical Specifications

Model	DH-HAC-HDW2220R-VF	DH-HAC-HDW2220RN-VF
<b>Camera</b>		
Image Sensor	1/2.8" 2.4Megapixel CMOS	
Effective Pixels	1984(H)×1225(V)	
Electronic Shutter	1/3s~1/100,000s	
Video Frame Rate	25/30/50/60fps@720P; 25/30fps@1080P	
Synchronization	Internal	
Mini. Illumination	0.05Lux@F1.2(AGC ON), 0Lux IR on	
Video Output	1-channel BNC HDCVI high definition video output/ CVBS standard definition video output (Can switch)	
<b>Camera Features</b>		
Max. IR LEDs Length	30m, Smart IR	
Day/Night	Auto(ICR) / Color / B/W	
Noise Reduction	2D/3D	
OSD Menu	Support	
<b>Lens</b>		
Focal Length	2.7~12mm	
Angle of View	H: 105.5°~32.9°	
Lens Type	Manual / Fixed Iris	
Mount Type	Φ14	
<b>General</b>		
Power Supply	DC12V±10%	
Power Consumption	Max 4.5W	
Working Environment	-30°C~+60°C / Less than 95%RH (no condensation)	
Transmission Distance	Over 500m via 75-3 coaxial cable	
Ingress Protection	IP67	
Dimensions(W×D×H)	Φ119mm×97.4mm	
Weight	0.55kg	
Material	Metal	



## Features

- 1/2.8" 2.4Megapixel CMOS
- 25/30@1080P, 25/30/50/60fps@720P
- High speed, long distance real-time transmission
- HD and standard definition switchable
- OSD Menu, control over coaxial cable
- DWDR, Day/Night(ICR), AWB, AGC, BLC, 3D-DNR
- 2.7~12mm vari-focal lens
- Max. IR LEDs length 30m, Smart IR
- IP67, DC12V

## Dimensions (mm)

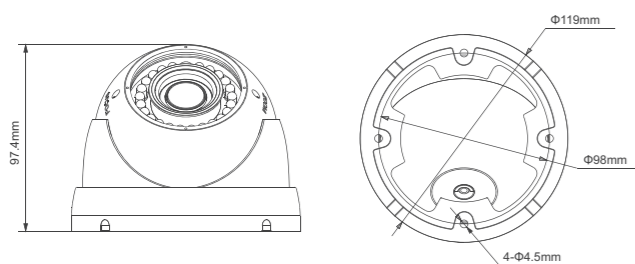

## Accessories (optional)



# DH-HAC-HFW2220D-B/HFW2220B-B



2.4Megapixel 1080P Water-proof HDCVI IR-Bullet Camera



## Technical Specifications

Model	DH-HAC-HFW2220D/N-B	DH-HAC-HFW2220B/N-B
<b>Camera</b>		
Image Sensor	1/2.8" 2.4Megapixel CMOS	
Effective Pixels	1984(H)×1225(V)	
Electronic Shutter	1/3s~1/100,000s	
Video Frame Rate	25/30/50/60fps@720P; 25/30fps@1080P	
Synchronization	Internal	
Min. Illumination	0.05Lux@F1.2(AGC ON), 0Lux IR on	
Video Output	1-channel BNC HDCVI high definition video output/ CVBS standard definition video output (Can switch)	
<b>Camera Features</b>		
Max. IR LEDs Length	80m, Smart IR	50m, Smart IR
Day/Night	Auto(ICR) / Color / B/W	
Noise Reduction	2D/3D	
OSD Menu	Support	
<b>Lens</b>		
Focal length	8mm fixed lens (3.6mm, 6mm, 12mm, 16mm optional)	6mm (3.6mm, 8mm optional)
Angle of View	H:39°(68°/53.4°/24.6°/19°)	H:53.4°(68°/39°)
Mount Type	M12	
<b>General</b>		
Power Supply	DC12V±10%	
Power Consumption	Max 8W	Max 6W
Working Environment	-30°C~+60°C / Less than 95%RH (no condensation)	
Transmission Distance	Over 500m via 75-3 coaxial cable	
Ingress Protection	IP67	
Dimensions(W×D×H)	200.2mm×89.1mm×161.2mm	
Weight	0.58kg	
Material	Metal(front) + Plastic(body)	



## Features

- 1/2.8" 2.4Megapixel CMOS
- 25/30fps@1080P, 25/30/50/60fps@720P
- High speed, long distance real-time transmission
- HD and standard definition switchable
- OSD Menu, control over coaxial cable
- DWDR, Day/Night(ICR), AWB, AGC, BLC, 3D-DNR
- 8mm fixed lens (3.6 mm, 6mm, 12mm, 16mm optional) (HFW2220D-B)
- 6mm fixed lens (3.6mm, 8mm optional) (HFW2220B-B)
- Max. IR LEDs length 80m(HFW2220D-B)/50m(HFW2220B-B), Smart IR
- IP67, DC12V

## Dimensions(mm)

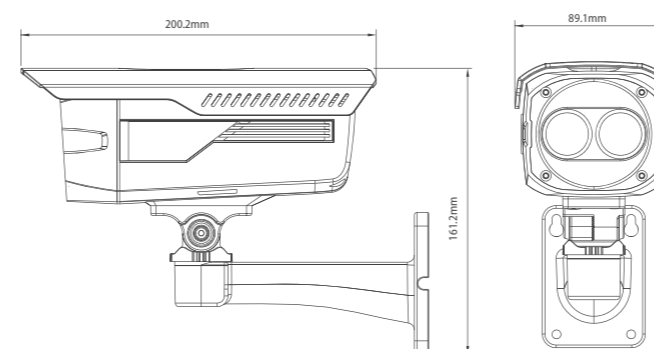

## Accessories (optional)



HDCVI DVR

HDCVI Camera

HDCVI PTZ Camera



# DH-HAC-HFW2220E NEW

## 2.4Megapixel 1080P Water-proof HDCVI IR-Bullet Camera



### Technical Specifications

Model	DH-HAC-HFW2220EP	DH-HAC-HFW2220EN
<b>Camera</b>		
Image Sensor	1/2.8" 2.4Megapixel CMOS	
Effective Pixels	1984(H)×1225(V)	
Electronic Shutter	1/3s~1/100,000s	
Video Frame Rate	25/30/50/60fps@720P; 25/30fps@1080P	
Synchronization	Internal	
Min. Illumination	0.05Lux@F1.2(AGC ON), 0Lux IR on	
Video Output	1-channel BNC HDCVI high definition video output/ CVBS standard definition video output (Can switch)	
<b>Camera Features</b>		
Max. IR LEDs Length	40m, Smart IR	
Day/Night	Auto(ICR) / Color / B/W	
Noise Reduction	2D/3D	
OSD Menu	Support	
<b>Lens</b>		
Focal Length	6mm (3.6mm, 8mm optional)	
Angle of View	H: 53.4°(88°/39°)	
Mount Type	M12	
<b>General</b>		
Power Supply	DC12V±10%	
Power Consumption	Max 5.5W	
Working Environment	-30°C~+60°C / Less than 95%RH (no condensation)	
Transmission Distance	Over 500m via 75-3 coaxial cable	
Ingress Protection	IP67	
Dimensions(W×D×H)	180mm×70mm×70.0mm	
Weight	0.4kg	
Material	Metal	



### Features

- 1/2.8" 2.4Megapixel CMOS
- 25/30fps@1080P, 25/30/50/60fps@720P
- High speed, long distance real-time transmission
- HD and standard definition switchable
- OSD Menu, control over coaxial cable
- DWDR, Day/Night(ICR), AWB, AGC, BLC, 3D-DNR
- 6mm fixed lens (3.6mm, 8mm optional)
- Max. IR LEDs length 40m, Smart IR
- IP67, DC12V

### Dimensions(mm)

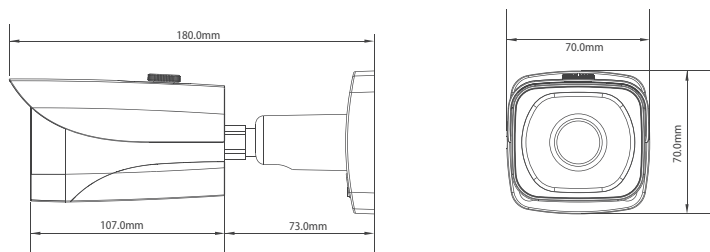

### Accessories (optional)



# DH-HAC-HFW2220S

## 2.4Megapixel 1080P Water-proof HDCVI IR-Bullet Camera



### Technical Specifications

Model	DH-HAC-HFW2220SP	DH-HAC-HFW2220SN
<b>Camera</b>		
Image Sensor	1/2.8" 2.4Megapixel CMOS	
Effective Pixels	1984(H)×1225(V)	
Electronic Shutter	1/3s~1/100,000s	
Video Frame Rate	25/30/50/60fps@720P; 25/30fps@1080P	
Synchronization	Internal	
Min. Illumination	0.05Lux@F1.2(AGC ON), 0Lux IR on	
Video Output	1-channel BNC HDCVI high definition video output/ CVBS standard definition video output (Can switch)	
<b>Camera Features</b>		
Max. IR LEDs Length	30m, Smart IR	
Day/Night	Auto(ICR) / Color / B/W	
Noise Reduction	2D/3D	
OSD Menu	Support	
<b>Lens</b>		
Focal length	6mm (3.6mm, 8mm optional)	
Angle of View	H: 53.4°(88°/39°)	
Mount Type	M12	
<b>General</b>		
Power Supply	DC12V±10%	
Power Consumption	Max 4.8W	
Working Environment	-30°C~+60°C / Less than 95%RH (no condensation)	
Transmission Distance	Over 500m via 75-3 coaxial cable	
Ingress Protection	IP67	
Dimensions(W×D×H)	Φ65mm×154.7mm	
Weight	0.38kg	
Material	Metal	



### Features

- 1/2.8" 2.4Megapixel CMOS
- 25/30fps@1080P, 25/30/50/60fps@720P
- High speed, long distance real-time transmission
- HD and standard definition switchable
- OSD Menu, control over coaxial cable
- DWDR, Day/Night(ICR), AWB, AGC, BLC, 3D-DNR
- 6mm fixed lens (3.6mm, 8mm optional)
- Max. IR LEDs length 30m, Smart IR
- IP67, DC12V

### Dimensions(mm)

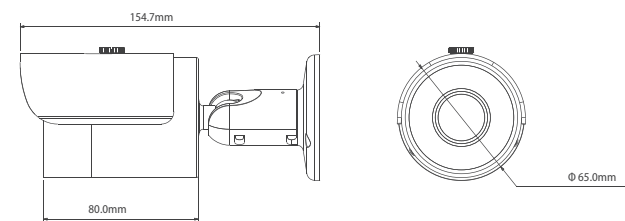

### Accessories (optional)



# DH-HAC-HDBW2220E

2.4Megapixel 1080P Vandal-proof IR HDCVI Mini Dome Camera



## Technical Specifications

Model	DH-HAC-HDBW2220EP	DH-HAC-HDBW2220EN
<b>Camera</b>		
Image Sensor	1/2.8" 2.4Megapixel CMOS	
Effective Pixels	1984(H)×1225(V)	
Electronic Shutter	1/3s~1/100,000s	
Video Frame Rate	25/30/50/60fps@720P; 25/30fps@1080P	
Synchronization	Internal	
Min. Illumination	0.05Lux@F1.2(AGC ON), 0Lux IR on	
Video Output	1-channel BNC HDCVI high definition video output/ CVBS standard definition video output (Can switch)	
<b>Camera Features</b>		
Max. IR LEDs Length	30m, Smart IR	
Day/Night	Auto(ICR) / Color / B/W	
Noise Reduction	2D/3D	
OSD Menu	Support	
<b>Lens</b>		
Focal Length	3.6mm (6mm, 8mm optional)	
Angle of View	H: 88°(53.4°/39°)	
Mount Type	M12	
<b>General</b>		
Power Supply	DC12V±10%	
Power Consumption	Max 3.5W	
Working Environment	-30°C~+60°C / Less than 95%RH (no condensation)	
Transmission Distance	Over 500m via 75-3 coaxial cable	
Ingress Protection	IP67 & IK10	
Dimensions(W×D×H)	Φ109.9mm×81.0mm	
Weight	0.3kg	
Material	Metal	



## Features

- 1/2.8" 2.4Megapixel CMOS
- 25/30fps@1080P, 25/30/50/60fps@720P
- High speed, long distance real-time transmission
- HD and standard definition switchable
- OSD Menu, control over coaxial cable
- DWDR, Day/Night(ICR), AWB, AGC, BLC, 3D-DNR
- 6mm fixed lens (3.6mm, 8mm optional)
- Max. IR LEDs length 30m, Smart IR
- IP67, IK10, DC12V

## Dimensions(mm)

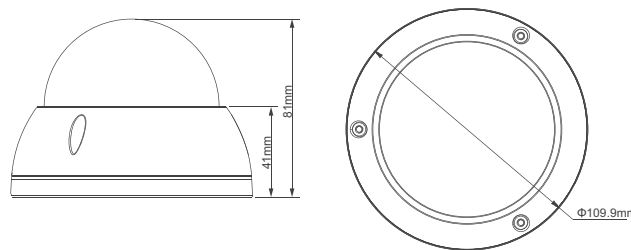

## Accessories (optional)



# DH-HAC-HDBW2220F NEW

2.4Megapixel 1080P Vandal-proof IR HDCVI Mini Dome Camera



## Technical Specifications

Model	DH-HAC-HDBW2220FP	DH-HAC-HDBW2220FN
<b>Camera</b>		
Image Sensor	1/2.8" 2.4Megapixel CMOS	
Effective Pixels	1984(H)×1225(V)	
Electronic Shutter	1/3s~1/100,000s	
Video Frame Rate	25/30/50/60fps@720P; 25/30fps@1080P	
Synchronization	Internal	
Mini. Illumination	0.05Lux@F1.2(AGC ON), 0Lux IR on	
Video Output	1-channel BNC HDCVI high definition video output / CVBS standard definition video output (Can switch) Tester out (1-channel BNC HDCVI high definition video output / CVBS standard definition video output)	
<b>Camera Features</b>		
Max. IR LEDs Length	20m, Smart IR	
Day/Night	Auto(ICR) / Color / B/W	
Noise Reduction	2D/3D	
OSD Menu	Support	
<b>Lens</b>		
Focal Length	3.6mm (6mm optional)	
Angle of View	H: 88°(53.4°)	
Mount Type	M12	
<b>General</b>		
Power Supply	DC12V±10%	
Power Consumption	Max 3.2W	
Working Environment	-30°C~+60°C / Less than 95%RH (no condensation)	
Transmission Distance	Over 500m via 75-3 coaxial cable	
Ingress Protection	IP67 & IK10	
Dimensions(W×D×H)	Φ106.3mm×51.1mm	
Weight	0.28kg	
Material	Metal	
Others	With pickup	



## Features

- 1/2.8" 2.4Megapixel CMOS
- 25/30@1080P, 25/30/50/60fps@720P
- High speed, long distance real-time transmission
- HD and standard definition switchable
- OSD Menu, control over coaxial cable; Audio
- Day/Night(ICR), AWB, AGC, BLC, 3D-DNR
- 3.6mm fixed lens (6mm optional)
- Max. IR LEDs length 20m, Smart IR
- IP67, IK10, DC12V

## Dimensions(mm)

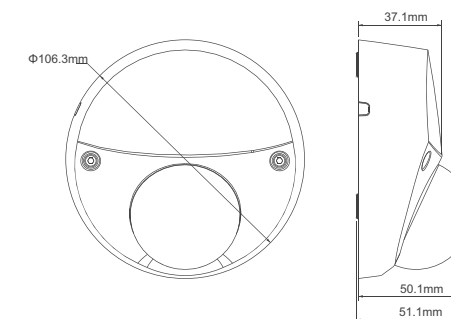

## Accessories (optional)



# DH-HAC-HDW2220E NEW

## 2.4Megapixel 1080P Water-proof IR HDCVI Dome Camera



### Features

- 1/2.8" 2.4Megapixel CMOS
- 25/30@1080P, 25/30/50/60fps@720P
- High speed, long distance real-time transmission
- HD and standard definition switchable
- OSD Menu, control over coaxial cable
- DWDR, Day/Night(ICR), AWB, AGC, BLC, 3D-DNR
- 3.6mm fixed lens (6mm, 8mm optional)
- Max. IR LEDs length 50m, Smart IR
- IP67, DC12V

### Dimensions(mm)

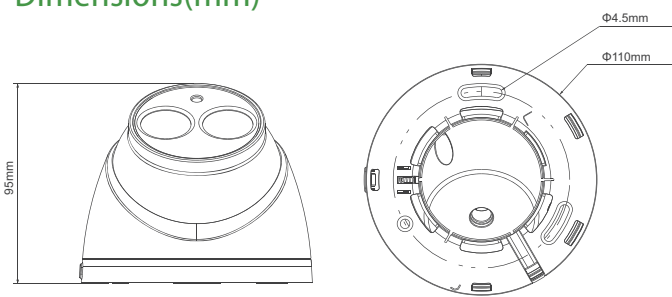

### Accessories (optional)



### Technical Specifications

Model	DH-HAC-HDW2220EP	DH-HAC-HDW2220EN
<b>Camera</b>		
Image Sensor	1/2.8" 2.4Megapixel CMOS	
Effective Pixels	1984(H)×1225(V)	
Electronic Shutter	1/3s~1/100,000s	
Video Frame Rate	25/30/50/60fps@720P; 25/30fps@1080P	
Synchronization	Internal	
Min. Illumination	0.05Lux@F1.2(AGC ON), 0Lux IR on	
Video Output	1-channel BNC HDCVI high definition video output/ CVBS standard definition video output (Can switch)	
<b>Camera Features</b>		
Max. IR LEDs Length	50m, Smart IR	
Day/Night	Auto(ICR) / Color / B/W	
Noise Reduction	2D/3D	
OSD Menu	Support	
<b>Lens</b>		
Focal Length	3.6mm (6mm, 8mm optional)	
Lens Type	H: 88°(53.4°/39°)	
Mount Type	M12	
<b>General</b>		
Power Supply	DC12V±10%	
Power Consumption	Max 5W	
Working Environment	-30°C~+60°C / Less than 95%RH (no condensation)	
Transmission Distance	Over 500m via 75-3 coaxial cable	
Ingress Protection	IP67	
Dimensions(W×D×H)	Φ110mm×95mm	
Weight	0.3kg	
Material	Metal (inner core) + Plastic (outside)	

# DH-HAC-HDW2220M

## 2.4Megapixel 1080P Water-proof IR HDCVI Mini Dome Camera



### Features

- 1/2.8" 2.4Megapixel CMOS
- 25/30fps@1080P, 25/30/50/60fps@720P
- High speed, long distance real-time transmission
- HD and standard definition switchable
- OSD Menu, control over coaxial cable
- DWDR, Day/Night(ICR), AWB, AGC, BLC, 3D-DNR
- 3.6mm fixed lens (6mm, 8mm optional)
- Max. IR LEDs length 30m, Smart IR
- IP67, DC12V

### Dimensions(mm)

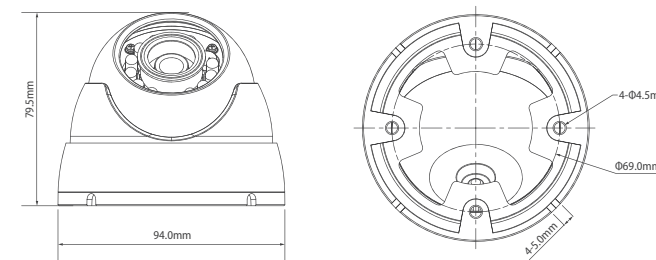

### Accessories (optional)



### Technical Specifications

Model	DH-HAC-HDW2220MP	DH-HAC-HDW2220MN
<b>Camera</b>		
Image Sensor	1/2.8" 2.4Megapixel CMOS	
Effective Pixels	1984(H)×1225(V)	
Electronic Shutter	1/3s~1/100,000s	
Video Frame Rate	25/30/50/60fps@720P; 25/30fps@1080P	
Synchronization	Internal	
Min. Illumination	0.05Lux@F1.2(AGC ON), 0Lux IR on	
Video Output	1-channel BNC HDCVI high definition video output/ CVBS standard definition video output (Can switch)	
<b>Camera Features</b>		
Max. IR LEDs Length	30m, Smart IR	
Day/Night	Auto(ICR) / Color / B/W	
Noise Reduction	2D/3D	
OSD Menu	Support	
<b>Lens</b>		
Focal Length	3.6mm (6mm, 8mm optional)	
Angle of View	H: 88°(53.4°/39°)	
Mount Type	M12	
<b>General</b>		
Power Supply	DC12V±10%	
Power Consumption	Max 3.5W	
Working Environment	-30°C~+60°C / Less than 95%RH (no condensation)	
Transmission Distance	Over 500m via 75-3 coaxial cable	
Ingress Protection	IP67	
Dimensions	Φ94.0mm×79.5mm	
Weight	0.35kg	
Material	Metal	

# DH-HAC-HDW2220S

2.4Megapixel 1080P Water-proof IR HDCVI Mini Dome Camera



## Features

- 1/2.8" 2.4Megapixel CMOS
- 25/30fps@1080P, 25/30/50/60fps@720P
- High speed, long distance real-time transmission
- HD and standard definition switchable
- OSD Menu, control over coaxial cable
- DWDR, Day/Night(ICR), AWB, AGC, BLC, 3D-DNR
- 3.6mm fixed lens (6mm, 8mm optional)
- Max. IR LEDs length 30m, Smart IR
- IP67, DC12V

## Dimensions(mm)

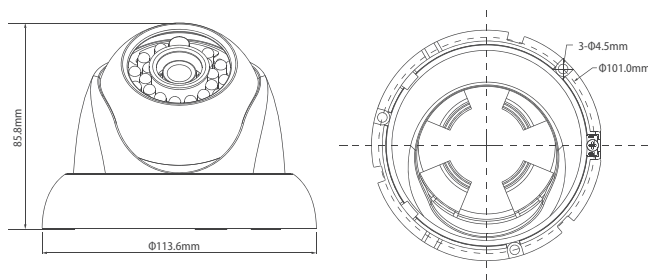

## Accessories (optional)



## Technical Specifications

Model	DH-HAC-HDW2220SP	DH-HAC-HDW2220SN
<b>Camera</b>		
Image Sensor	1/2.8" 2.4Megapixel CMOS	
Effective Pixels	1984(H)×1225(V)	
Electronic Shutter	1/3s~1/100,000s	
Video Frame Rate	25/30/50/60fps@720P; 25/30fps@1080P	
Synchronization	Internal	
Min. Illumination	0.05Lux@F1.2(AGC ON), 0Lux IR on	
Video Output	1-channel BNC HDCVI high definition video output/ CVBS standard definition video output (Can switch)	
<b>Camera Features</b>		
Max. IR LEDs Length	30m, Smart IR	
Day/Night	Auto(ICR) / Color / B/W	
Noise Reduction	2D/3D	
OSD Menu	Support	
<b>Lens</b>		
Focal Length	3.6mm (6mm, 8mm optional)	
Angle of View	H: 88°(53.4°/39°)	
Mount Type	M12	
<b>General</b>		
Power Supply	DC12V±10%	
Power Consumption	Max 3.5W	
Working Environment	-30°C~+60°C / Less than 95%RH (no condensation)	
Transmission Distance	Over 500m via 75-3 coaxial cable	
Ingress Protection	IP67	
Dimensions	Ø108mm×85.4mm	
Weight	0.35kg	
Material	Metal (inner core) + Plastic (outside)	

# DH-HAC-HFW1200R-VF(-IRE6) NEW

2Megapixel 1080P Water-proof HDCVI IR-Bullet Camera



## Features

- 1/2.7" 2Megapixel CMOS
- 25/30fps@1080P
- High speed, long distance real-time transmission
- Day/Night(ICR), AWB, AGC, BLC, 2D-DNR
- 2.7~12mm vari-focal lens
- Max. IR LEDs length 30m (60m optional), Smart IR
- IP67, DC12V

## Dimensions (mm)

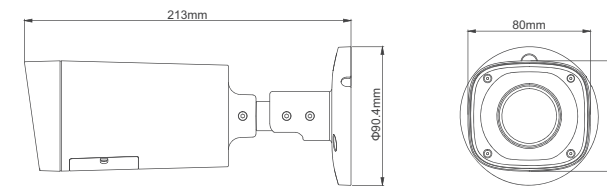

## Accessories (optional)



## Technical Specifications

Model	DH-HAC-HFW1200RP-VF	DH-HAC-HFW1200RN-VF
<b>Camera</b>		
Image Sensor	1/2.7" 2Megapixel CMOS	
Effective Pixels	1930(H)×1088(V)	
Electronic Shutter	1/50s~1/100,000s	1/60s~1/100,000s
Video Frame Rate	25fps@1080P	30fps@1080P
Synchronization	Internal	
Mini. Illumination	0.01Lux@F1.2(AGC ON), 0Lux IR on	
Video Output	1-channel BNC HDCVI high definition video output	
<b>Camera Features</b>		
Max. IR LEDs Length	30m (60m optional), Smart IR	
Day/Night	Auto(ICR) / Color / B/W	
Noise Reduction	2D	
<b>Lens</b>		
Focal Length	2.7~12mm	
Angle of View	H: 109°~35°	
Lens Type	Manual / Fixed Iris	
Mount Type	Ø14	
<b>General</b>		
Power Supply	DC12V±20%	
Power Consumption	Max 3.8W(30m IR)/ 8.5W (60m IR)	
Working Environment	-30°C~+60°C / Less than 95%RH (no condensation)	
Transmission Distance	Over 500m via 75-3 coaxial cable	
Ingress Protection	IP67	
Dimensions(W×D×H)	213mm×80mm×72mm	
Weight	0.55kg	
Material	Metal	

# DH-HAC-HDBW1200R-VF NEW

## 2Megapixel 1080P Vandal-proof IR HDCVI Dome Camera



### Technical Specifications

Model	DH-HAC-HDBW1200RP-VF	DH-HAC-HDBW1200RN-VF
<b>Camera</b>		
Image Sensor	1/2.7" 2Megapixel CMOS	
Effective Pixels	1930(H)×1088(V)	
Electronic Shutter	1/50s~1/100,000s	1/60s~1/100,000s
Video Frame Rate	25fps@1080P	30fps@1080P
Synchronization	Internal	
Min. Illumination	0.01Lux@F1.2(AGC ON), 0Lux IR on	
Video Output	1-channel BNC HDCVI high definition video output	
<b>Camera Features</b>		
Max. IR LEDs Length	30m, Smart IR	
Day/Night	Auto(ICR) / Color / B/W	
Noise Reduction	2D	
<b>Lens</b>		
Focal Length	2.7~12mm	
Angle of View	H: 109°~35°	
Lens Type	Manual / Fixed Iris	
Mount Type	Φ14	
<b>General</b>		
Power Supply	DC12V±20%	
Power Consumption	Max 5.8W	
Working Environment	-30°C~+60°C / Less than 95%RH (no condensation)	
Transmission Distance	Over 500m via 75-3 coaxial cable	
Ingress Protection	IP67 & IK10	
Dimensions	Φ122mm×89mm	
Weight	0.45kg	
Material	Metal	



### Features

- 1/2.7" 2Megapixel CMOS
- 25/30fps@1080P
- High speed, long distance real-time transmission
- Day/Night(ICR), AWB, AGC, BLC, 2D-DNR
- 2.7~12mm vari-focal lens
- Max. IR LEDs length 30m, Smart IR
- IP67, IK10, DC12V

### Dimensions(mm)

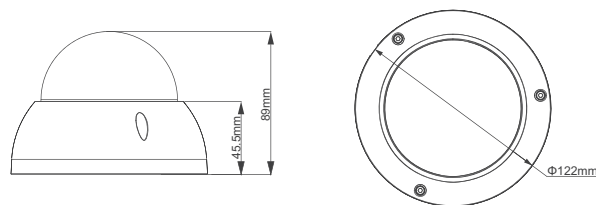

### Accessories (optional)



# DH-HAC-HDW1200R-VF NEW

## 2Megapixel 1080P Water-proof IR HDCVI Dome Camera



### Technical Specifications

Model	DH-HAC-HDW1200RP-VF	DH-HAC-HDW1200RN-VF
<b>Camera</b>		
Image Sensor	1/2.7" 2Megapixel CMOS	
Effective Pixels	1930(H)×1088(V)	
Electronic Shutter	1/50s~1/100,000s	1/60s~1/100,000s
Video Frame Rate	25fps@1080P	30fps@1080P
Synchronization	Internal	
Min. Illumination	0.01Lux@F1.2(AGC ON), 0Lux IR on	
Video Output	1-channel BNC HDCVI high definition video output	
<b>Camera Features</b>		
Max. IR LEDs Length	30m, Smart IR	
Day/Night	Auto(ICR) / Color / B/W	
Noise Reduction	2D	
<b>Lens</b>		
Focal Length	2.7~12mm	
Angle of View	H: 109°~35°	
Lens Type	Manual / Fixed Iris	
Mount Type	Φ14	
<b>General</b>		
Power Supply	DC12V±20%	
Power Consumption	Max 3.8W	
Working Environment	-30°C~+60°C / Less than 95%RH (no condensation)	
Transmission Distance	Over 500m via 75-3 coaxial cable	
Ingress Protection	IP67	
Dimensions	Φ119mm×97.4mm	
Weight	0.55kg	
Material	Metal	



### Features

- 1/2.7" 2Megapixel CMOS
- 25/30fps@1080P
- High speed, long distance real-time transmission
- Day/Night(ICR), AWB, AGC, BLC, 2D-DNR
- 2.7~12mm vari-focal lens
- Max. IR LEDs length 30m, Smart IR
- IP67, DC12V

### Dimensions (mm)

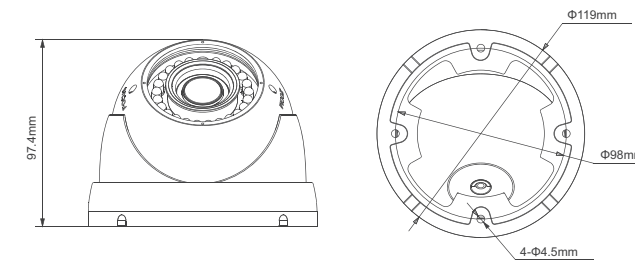

### Accessories (optional)



# DH-HAC-HFW1200B NEW

## 2Megapixel 1080P Water-proof HDCVI IR-Bullet Camera

### Technical Specifications

Model	DH-HAC-HFW1200BP	DH-HAC-HFW1200BN
<b>Camera</b>		
Image Sensor	1/2.7" 2Megapixel CMOS	
Effective Pixels	1930(H)×1088(V)	
Electronic Shutter	1/50s~1/100,000s	1/60s~1/100,000s
Video Frame Rate	25fps@1080P	30fps@1080P
Synchronization	Internal	
Min. Illumination	0.01Lux@F1.2(AGC ON), 0Lux IR on	
Video Output	1-channel BNC HDCVI high definition video output	
<b>Camera Features</b>		
Max. IR LEDs Length	50m, Smart IR	
Day/Night	Auto(ICR) / Color / B/W	
Noise Reduction	2D	
<b>Lens</b>		
Focal length	3.6mm (6mm, 8mm optional)	
Angle of View	H: 89.9°(54.9°/41.4°)	
Mount Type	M12	
<b>General</b>		
Power Supply	DC12V±20%	
Power Consumption	Max 4.5W	
Working Environment	-30°C~+60°C / Less than 95%RH (no condensation)	
Transmission Distance	Over 500m via 75-3 coaxial cable	
Ingress Protection	IP67	
Dimensions(W×D×H)	279.9mm×90mm×47.5mm	
Weight	0.33kg	
Material	Metal (front) + Plastic (body)	



### Features

- 1/2.7" 2Megapixel CMOS
- 25/30fps@1080P
- High speed, long distance real-time transmission
- Day/Night(ICR), AWB, AGC, BLC, 2D-DNR
- 3.6mm fixed lens (6mm, 8mm optional)
- Max. IR LEDs length 50m, Smart IR
- IP67, DC12V

### Dimensions(mm)

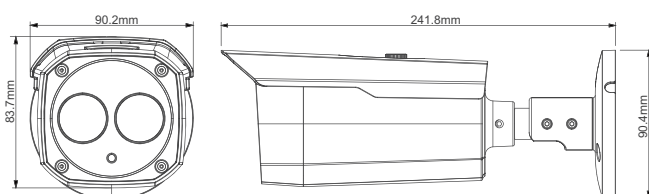

### Accessories (optional)



# DH-HAC-HFW1200S NEW

## 2Megapixel 1080P Water-proof HDCVI IR-Bullet Camera

### Technical Specifications

Model	DH-HAC-HFW1200SP	DH-HAC-HFW1200SN
<b>Camera</b>		
Image Sensor	1/2.7" 2Megapixel CMOS	
Effective Pixels	1930(H)×1088(V)	
Electronic Shutter	1/50s~1/100,000s	1/60s~1/100,000s
Video Frame Rate	25fps@1080P	30fps@1080P
Synchronization	Internal	
Min. Illumination	0.01Lux@F1.2(AGC ON), 0Lux IR on	
Video Output	1-channel BNC HDCVI high definition video output	
<b>Camera Features</b>		
Max. IR LEDs Length	30m, Smart IR	
Day/Night	Auto(ICR) / Color / B/W	
Noise Reduction	2D	
<b>Lens</b>		
Focal length	3.6mm (6mm, 8mm optional)	
Angle of View	H: 89.9°(59.4°/41.4°)	
Mount Type	M12	
<b>General</b>		
Power Supply	DC12V±20%	
Power Consumption	Max 3.6W	
Working Environment	-30°C~+60°C / Less than 95%RH (no condensation)	
Transmission Distance	Over 500m via 75-3 coaxial cable	
Ingress Protection	IP67	
Dimensions(W×D×H)	Φ70mm×165mm	
Weight	0.35kg	
Material	Metal (body) + Plastic (sun shield)	



### Features

- 1/2.7" 2Megapixel CMOS
- 25/30fps@1080P
- High speed, long distance real-time transmission
- Day/Night(ICR), AWB, AGC, BLC, 2D-DNR
- 3.6mm fixed lens (6mm, 8mm optional)
- Max. IR LEDs length 30m, Smart IR
- IP67, DC12V

### Dimensions(mm)

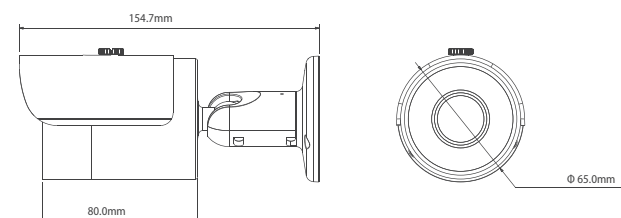

### Accessories (optional)



# DH-HAC-HFW1200RM NEW

## 2Megapixel 1080P Water-proof HDCVI IR-Bullet Camera



### Technical Specifications

Model	DH-HAC-HFW1200RMP	DH-HAC-HFW1200RMN
<b>Camera</b>		
Image Sensor	1/2.7" 2Megapixel CMOS	
Effective Pixels	1930(H)×1088(V)	
Electronic Shutter	1/50s~1/100,000s	1/60s~1/100,000s
Video Frame Rate	25fps@1080P	30fps@1080P
Synchronization	Internal	
Min. Illumination	0.01Lux@F1.2(AGC ON), 0Lux IR on	
Video Output	1-channel BNC HDCVI high definition video output	
<b>Camera Features</b>		
Max. IR LEDs Length	20m, Smart IR	
Day/Night	Auto(ICR) / Color / B/W	
Noise Reduction	2D	
<b>Lens</b>		
Focal length	3.6mm fixed lens (6mm optional)	
Angle of View	H: 89.9°(59.4°)	
Mount Type	M12	
<b>General</b>		
Power Supply	DC12V±20%	
Power Consumption	Max 3.5W	
Working Environment	-30°C~+60°C / Less than 95%RH (no condensation)	
Transmission Distance	Over 500m via 75-3 coaxial cable	
Ingress Protection	IP67	
Dimensions(W×D×H)	Φ70mm×154mm	
Weight	0.3kg	
Material	Metal	



### Features

- 1/2.7" 2Megapixel CMOS
- 25/30fps@1080P
- High speed, long distance real-time transmission
- Day/Night(ICR), AWB, AGC, BLC, 2D-DNR
- 3.6mm fixed lens (6mm optional)
- Max. IR LEDs length 20m, Smart IR
- IP67, DC12V

### Dimensions(mm)

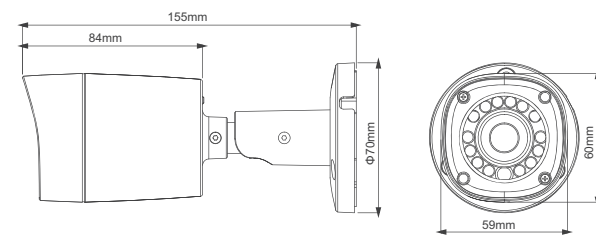

### Accessories (optional)



# DH-HAC-HFW1200R NEW

## 2Megapixel 1080P Water-proof HDCVI IR-Bullet Camera



### Technical Specifications

Model	DH-HAC-HFW1200RP	DH-HAC-HFW1200RN
<b>Camera</b>		
Image Sensor	1/2.7" 2Megapixel CMOS	
Effective Pixels	1930(H)×1088(V)	
Electronic Shutter	1/50s~1/100,000s	1/60s~1/100,000s
Video Frame Rate	25fps@1080P	30fps@1080P
Synchronization	Internal	
Min. Illumination	0.01Lux@F1.2(AGC ON), 0Lux IR on	
Video Output	1-channel BNC HDCVI high definition video output	
<b>Camera Features</b>		
Max. IR LEDs Length	20m, Smart IR	
Day/Night	Auto(ICR) / Color / B/W	
Noise Reduction	2D	
<b>Lens</b>		
Focal length	3.6mm fixed lens (6mm optional)	
Angle of View	H: 89.9°(59.4°)	
Mount Type	M12	
<b>General</b>		
Power Supply	DC12V±20%	
Power Consumption	Max 3.5W	
Working Environment	-30°C~+60°C / Less than 95%RH (no condensation)	
Transmission Distance	Over 500m via 75-3 coaxial cable	
Ingress Protection	IP67	
Dimensions(W×D×H)	Φ70mm×154mm	
Weight	0.2kg	
Material	Plastic	



### Features

- 1/2.7" 2Megapixel CMOS
- 25/30fps@1080P
- High speed, long distance real-time transmission
- Day/Night(ICR), AWB, AGC, BLC, 2D-DNR
- 3.6mm fixed lens (6mm optional)
- Max. IR LEDs length 20m, Smart IR
- IP67, DC12V

### Dimensions(mm)

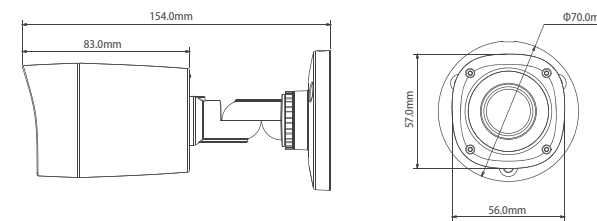

### Accessories (optional)



# DH-HAC-HDBW1200E NEW

## 2Megapixel 1080P Vandal-proof IR HDCVI Mini Dome Camera



### Features

- 1/2.7" 2Megapixel CMOS
- 25/30fps@1080P
- High speed, long distance real-time transmission
- Day/Night(ICR), AWB, AGC, BLC, 2D-DNR
- 3.6mm fixed lens (6mm, 8mm optional)
- Max. IR LEDs length 30m, Smart IR
- IP67, IK10, DC12V

### Dimensions(mm)

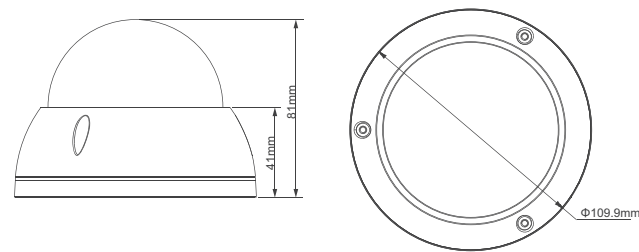

### Accessories (optional)



### Technical Specifications

Model	DH-HAC-HDBW1200EP	DH-HAC-HDBW1200EN
<b>Camera</b>		
Image Sensor	1/2.7" 2Megapixel CMOS	
Effective Pixels	1930(H)×1088(V)	
Electronic Shutter	1/50s~1/100,000s	1/60s~1/100,000s
Video Frame Rate	25fps@1080P	30fps@1080P
Synchronization	Internal	
Min. Illumination	0.01Lux@F1.2(AGC ON), 0Lux IR on	
Video Output	1-channel BNC HDCVI high definition video output	
<b>Camera Features</b>		
Max. IR LEDs Length	30m, Smart IR	
Day/Night	Auto(ICR) / Color / B/W	
Noise Reduction	2D	
<b>Lens</b>		
Focal length	3.6mm (6mm, 8mm optional)	
Angle of View	H: 89.9°(59.4°/41.4°)	
Mount Type	M12	
<b>General</b>		
Power Supply	DC12V±20%	
Power Consumption	Max 3.5W	
Working Environment	-30°C~+60°C / Less than 95%RH (no condensation)	
Transmission Distance	Over 500m via 75-3 coaxial cable	
Ingress Protection	IP67 & IK10	
Dimensions(W×D×H)	Φ109.9mm×81.0mm	
Weight	0.3kg	
Others	Metal	

# DH-HAC-HDW1200E NEW

## 2Megapixel 1080P Water-proof IR HDCVI Dome Camera



### Features

- 1/2.7" 2Megapixel CMOS
- 25/30fps@1080P
- High speed, long distance real-time transmission
- Day/Night(ICR), AWB, AGC, BLC, 2D-DNR
- 3.6mm fixed lens (6mm optional)
- Max. IR LEDs length 50m, Smart IR
- IP67, DC12V

### Dimensions(mm)

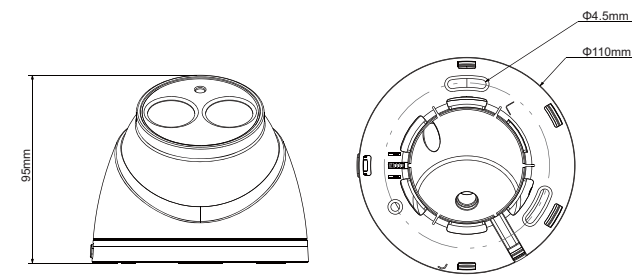

### Accessories (optional)



### Technical Specifications

Model	DH-HAC-HDW1200EP	DH-HAC-HDW1200EN
<b>Camera</b>		
Image Sensor	1/2.7" 2Megapixel CMOS	
Effective Pixels	1930(H)×1088(V)	
Electronic Shutter	1/50s~1/100,000s	1/60s~1/100,000s
Video Frame Rate	25fps@1080P	30fps@1080P
Synchronization	Internal	
Min. Illumination	0.01Lux@F1.2(AGC ON), 0Lux IR on	
Video Output	1-channel BNC HDCVI high definition video output	
<b>Camera Features</b>		
Max. IR LEDs Length	50m, Smart IR	
Day/Night	Auto(ICR) / Color / B/W	
Noise Reduction	2D	
<b>Lens</b>		
Focal length	3.6mm (6mm optional)	
Angle of View	H: 89.9°(59.4°)	
Mount Type	M12	
<b>General</b>		
Power Supply	DC12V±20%	
Power Consumption	Max 3.6W	
Working Environment	-30°C~+60°C / Less than 95%RH (no condensation)	
Transmission Distance	Over 500m via 75-3 coaxial cable	
Ingress Protection	IP67	
Dimensions(W×D×H)	Φ110mm×95.0mm	
Weight	0.3kg	
Material	Metal (inner core) + Plastic (outside)	

HDCVI DVR  
HDCVI Camera  
HDCVI PTZ Camera



# DH-HAC-HDW1200M NEW

## 2Megapixel 1080P Water-proof IR HDCVI Mini Dome Camera



### Features

- 1/2.7" 2Megapixel CMOS
- 25/30fps@1080P
- High speed, long distance real-time transmission
- Day/Night(ICR), AWB, AGC, BLC, 2D-DNR
- 3.6mm fixed lens (6mm optional)
- Max. IR LEDs length 30m, Smart IR
- IP67, DC12V

### Dimensions(mm)

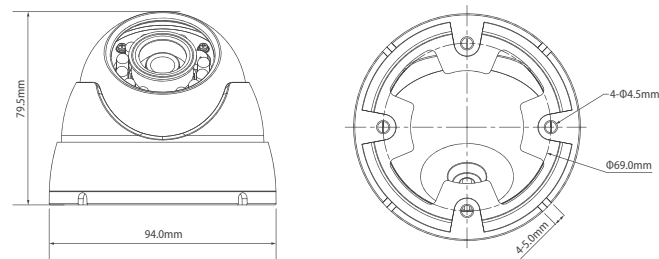

### Accessories (optional)



### Technical Specifications

Model	DH-HAC-HDW1200MP	DH-HAC-HDW1200MN
<b>Camera</b>		
Image Sensor	1/2.7" 2Megapixel CMOS	
Effective Pixels	1930(H)×1088(V)	
Electronic Shutter	1/50s~1/100,000s	1/60s~1/100,000s
Video Frame Rate	25fps@1080P	30fps@1080P
Synchronization	Internal	
Min. Illumination	0.01Lux@F1.2(AGC ON), 0Lux IR on	
Video Output	1-channel BNC HDCVI high definition video output	
<b>Camera Features</b>		
Max. IR LEDs Length	30m, Smart IR	
Day/Night	Auto(ICR) / Color / B/W	
Noise Reduction	2D	
<b>Lens</b>		
Focal length	3.6mm (6mm optional)	
Angle of View	H: 89.9°(59.4°)	
Mount Type	M12	
<b>General</b>		
Power Supply	DC12V±20%	
Power Consumption	Max 2.5W	
Working Environment	-30°C~+60°C / Less than 95%RH (no condensation)	
Transmission Distance	Over 500m via 75-3 coaxial cable	
Ingress Protection	IP67	
Dimensions(W×D×H)	Φ94.0mm×79.5mm	
Weight	0.35kg	
Others	Metal	

# DH-HAC-HF3101

## 1.3Megapixel 720P WDR HDCVI Camera



### Features

- 1/3" 1.3Megapixel CMOS
- 25/30fps@720P
- High speed, long distance real-time transmission
- HD and standard definition switch
- OSD Menu, control over coaxial cable
- WDR(120dB), Day/Night(ICR), 3D-DNR, Auto Iris
- AC24V/DC12V

### Dimensions (mm)

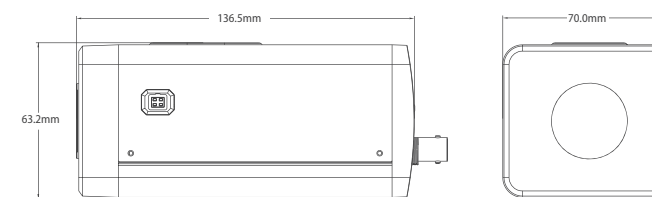

### Accessories (optional)



### Technical Specifications

Model	DH-HAC-HF3101P	DH-HAC-HF3101N
<b>Camera</b>		
Image Sensor	1/3" 1.3Megapixel CMOS	
Effective Pixels	1280(H)×960(V)	
Electronic Shutter	1/1s~1/10,000s	
Video Frame Rate	25/30fps@720P	
Synchronization	Internal	
Min. Illumination	Color: 0.01Lux@F1.2(AGC ON) ; B/W: 0.001Lux@F1.2(AGC ON)	
Video Output	1-channel BNC HDCVI high definition video output/ CVBS standard definition video output (Can switch)	
<b>Camera Features</b>		
Day/Night	Auto(ICR) / Color / B/W	
Backlight Compensation	WDR (120dB)	
Noise Reduction	2D/3D	
OSD Menu	Support	
<b>Lens</b>		
Focal length	N/A	
Mount Type	C/CS	
<b>Auxiliary Interface</b>		
RS485	1	
Alarm	1 channel out	
Audio	1 channel in	
<b>General</b>		
Power Supply	AC24V/DC12V	
Power Consumption	Max 7W	
Working Environment	-30°C~+60°C / Less than 95%RH (no condensation)	
Transmission Distance	Over 800m via 75-3 coaxial cable	
Dimensions(W×D×H)	70mm×63.2mm×136.5mm	
Weight	0.65kg	
Material	Metal	

# DH-HAC-HFW2120R-Z(-IRE6)



## 1.4Megapixel 720P Water-proof HDCVI IR-Bullet Camera

### Technical Specifications

Model	DH-HAC-HFW2120RP-Z	DH-HAC-HFW2120RN-Z
<b>Camera</b>		
Image Sensor	1/3" 1.4Megapixel CMOS	
Effective Pixels	1305(H)×1049(V)	
Electronic Shutter	1/3s~1/100,000s	
Video Frame Rate	25/50fps@720P	30/60fps@720P
Synchronization	Internal	
Min. Illumination	0.01Lux@F1.2(AGC ON), 0Lux IR on	
Video Output	1-channel BNC HDCVI high definition video output/ CVBS standard definition video output (Can switch)	
<b>Camera Features</b>		
Max. IR LEDs Length	30m (60m optional), Smart IR	
Day/Night	Auto(ICR) / Color / B/W	
Noise Reduction	2D/3D	
OSD Menu	Support	
<b>Lens</b>		
Focal Length	2.7~12mm	
Angle of View	H: 90°~28.7°	
Lens Type	Motorized / Fixed Iris	
Mount Type	Φ14	
<b>General</b>		
Power Supply	DC12V±10%	
Power Consumption	Max 7.5W(30m IR) / 11W(60m IR)	
Working Environment	-30°C~+60°C / Less than 95%RH (no condensation)	
Transmission Distance	Over 800m via 75-3 coaxial cable	
Ingress Protection	IP67	
Dimensions(W×D×H)	213mm×80mm×72mm	
Weight	0.55kg	
Material	Metal	



### Features

- 1/3" 1.4Megapixel CMOS
- 25/30/50/60fps@720P
- High speed, long distance real-time transmission
- HD and standard definition switchable
- OSD Menu, control over coaxial cable
- DWDR, Day/Night(ICR), AWB, AGC, BLC, 3D-DNR
- 2.7~12mm motorized lens
- Max. IR LEDs length 30m (60m optional), Smart IR
- IP67, DC12V

### Dimensions(mm)

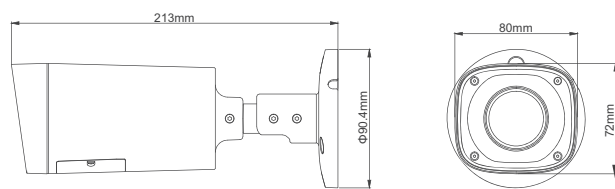

### Accessories (optional)



# DH-HAC-HFW2120R-VF(-IRE6)



## 1.4Megapixel 720P Water-proof HDCVI IR-Bullet Camera

### Technical Specifications

Model	DH-HAC-HFW2120RP-VF	DH-HAC-HFW2120RN-VF
<b>Camera</b>		
Image Sensor	1/3" 1.4Megapixel CMOS	
Effective Pixels	1305(H)×1049(V)	
Electronic Shutter	1/3s~1/100,000s	
Video Frame Rate	25/50fps@720P	30/60fps@720P
Synchronization	Internal	
Min. Illumination	0.01Lux@F1.2(AGC ON), 0Lux IR on	
Video Output	1-channel BNC HDCVI high definition video output/ CVBS standard definition video output (Can switch)	
<b>Camera Features</b>		
Max. IR LEDs Length	30m (60m optional), Smart IR	
Day/Night	Auto(ICR) / Color / B/W	
Noise Reduction	2D/3D	
OSD Menu	Support	
<b>Lens</b>		
Focal Length	2.7~12mm	
Angle of View	H: 90°~28.7°	
Lens Type	Manual / Fixed Iris	
Mount Type	Φ14	
<b>General</b>		
Power Supply	DC12V±10%	
Power Consumption	Max 2.6W (30m IR) / 8.5W(60m IR)	
Working Environment	-30°C~+60°C / Less than 95%RH (no condensation)	
Transmission Distance	Over 800m via 75-3 coaxial cable	
Ingress Protection	IP67	
Dimensions(W×D×H)	213mm×80mm×72mm	
Weight	0.55kg	
Material	Metal	



### Features

- 1/3" 1.4Megapixel CMOS
- 25/30/50/60fps@720P
- High speed, long distance real-time transmission
- HD and standard definition switchable
- OSD Menu, control over coaxial cable
- DWDR, Day/Night(ICR), AWB, AGC, BLC, 3D-DNR
- 2.7~12mm vari-focal lens
- Max. IR LEDs length 30m (60m optional), Smart IR
- IP67, DC12V

### Dimensions(mm)

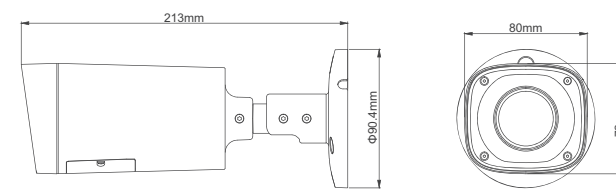

### Accessories (optional)



HDCVI DVR

HDCVI Camera

HDCVI PTZ Camera

# DH-HAC-HDBW2120R-Z

## 1.4Megapixel 720P Vandal-proof IR HDCVI Dome Camera



### Technical Specifications

Model	DH-HAC-HDBW2120RP-Z	DH-HAC-HDBW2120RN-Z
<b>Camera</b>		
Image Sensor	1/3" 1.4Megapixel CMOS	
Effective Pixels	1305(H)×1049(V)	
Electronic Shutter	1/3s~1/100,000s	
Video Frame Rate	25/50fps@720P	30/60fps@720P
Synchronization	Internal	
Min. Illumination	0.01Lux@F1.2(AGC ON), 0Lux IR on	
Video Output	1-channel BNC HDCVI high definition video output/ CVBS standard definition video output (Can switch)	
<b>Camera Features</b>		
Max. IR LEDs Length	30m, Smart IR	
Day/Night	Auto(ICR) / Color / B/W	
Noise Reduction	2D/3D	
OSD Menu	Support	
<b>Lens</b>		
Focal Length	2.7~12mm	
Angle of View	H: 90°~28.7°	
Lens Type	Motorized / Fixed Iris	
Mount Type	Φ14	
<b>General</b>		
Power Supply	DC12V±10%	
Power Consumption	Max 8.6W	
Working Environment	-30°C~+60°C / Less than 95%RH (no condensation)	
Transmission Distance	Over 800m via 75-3 coaxial cable	
Ingress Protection	IP67 & IK10	
Dimensions	Φ122mm×89mm	
Weight	0.45kg	
Material	Metal	



### Features

- 1/3" 1.4Megapixel CMOS
- 25/30/50/60fps@720P
- High speed, long distance real-time transmission
- HD and standard definition switchable
- OSD Menu, control over coaxial cable
- DWDR, Day/Night(ICR), AWB, AGC, BLC, 3D-DNR
- 2.7~12mm motorized lens
- Max. IR LEDs length 30m, Smart IR
- IP67, IK10, DC12V

### Dimensions(mm)

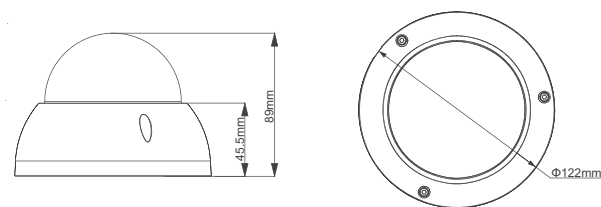

### Accessories (optional)



# DH-HAC-HDBW2120R-VF

## 1.4Megapixel 720P Vandal-proof IR HDCVI Dome Camera



### Technical Specifications

Model	DH-HAC-HDBW2120RP-VF	DH-HAC-HDBW2120RN-VF
<b>Camera</b>		
Image Sensor	1/3" 1.4Megapixel CMOS	
Effective Pixels	1305(H)×1049(V)	
Electronic Shutter	1/3s~1/100,000s	
Video Frame Rate	25/50fps@720P	30/60fps@720P
Synchronization	Internal	
Min. Illumination	0.01Lux@F1.2(AGC ON), 0Lux IR on	
Video Output	1-channel BNC HDCVI high definition video output/ CVBS standard definition video output (Can switch)	
<b>Camera Features</b>		
Max. IR LEDs Length	30m, Smart IR	
Day/Night	Auto(ICR) / Color / B/W	
Noise Reduction	2D/3D	
OSD Menu	Support	
<b>Lens</b>		
Focal Length	2.7~12mm	
Angle of View	H: 90°~28.7°	
Lens Type	Manual / Fixed Iris	
Mount Type	Φ14	
<b>General</b>		
Power Supply	DC12V±10%	
Power Consumption	Max 5.8W	
Working Environment	-30°C~+60°C / Less than 95%RH (no condensation)	
Transmission Distance	Over 800m via 75-3 coaxial cable	
Ingress Protection	IP67 & IK10	
Dimensions	Φ122mm×89mm	
Weight	0.45kg	
Material	Metal	



### Features

- 1/3" 1.4Megapixel CMOS
- 25/30/50/60fps@720P
- High speed, long distance real-time transmission
- HD and standard definition switchable
- OSD Menu, control over coaxial cable
- DWDR, Day/Night(ICR), AWB, AGC, BLC, 3D-DNR
- 2.7~12mm vari-focal lens
- Max. IR LEDs length 30m, Smart IR
- IP67, IK10, DC12V

### Dimensions(mm)

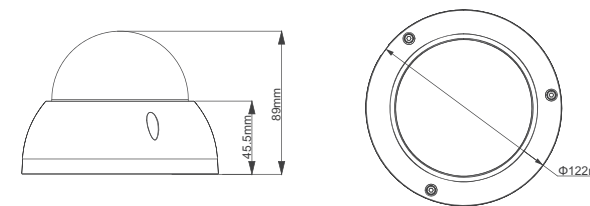

### Accessories (optional)



# DH-HAC-HDW2120E-Z NEW

## 1.4Megapixel 720P Water-proof IR HDCVI Dome Camera



### Technical Specifications

Model	DH-HAC-HDW2120EP-Z	DH-HAC-HDW2120EN-Z
<b>Camera</b>		
Image Sensor	1/3" 1.4Megapixel CMOS	
Effective Pixels	1305(H)×1049(V)	
Electronic Shutter	1/3s~1/100,000s	
Video Frame Rate	25/50fps@720P	30/60fps@720P
Synchronization	Internal	
Min. Illumination	0.01Lux@F1.2(AGC ON), 0Lux IR on	
Video Output	1-channel BNC HDCVI high definition video output/ CVBS standard definition video output (Can switch)	
<b>Camera Features</b>		
Max. IR LEDs Length	60m, Smart IR	
Day/Night	Auto(ICR) / Color / B/W	
Noise Reduction	2D/3D	
OSD Menu	Support	
<b>Lens</b>		
Focal Length	2.7~12mm	
Angle of View	H: 90°~28.7°	
Lens Type	Manual / Fixed Iris	
Mount Type	Φ14	
<b>General</b>		
Power Supply	DC12V±10%	
Power Consumption	Max 6.6W	
Working Environment	-30°C~+60°C / Less than 95%RH (no condensation)	
Transmission Distance	Over 800m via 75-3 coaxial cable	
Ingress Protection	IP67	
Dimensions	Φ122mm×102mm	
Weight	0.55kg	
Material	Metal	



### Features

- 1/3" 1.4Megapixel CMOS
- 25/30/50/60fps@720P
- High speed, long distance real-time transmission
- HD and standard definition switchable
- OSD Menu, control over coaxial cable
- DWDR, Day/Night(ICR), AWB, AGC, BLC, 3D-DNR
- 2.7~12mm motorized lens
- Max. IR LEDs length 60m, Smart IR
- IP67, DC12V

### Dimensions(mm)

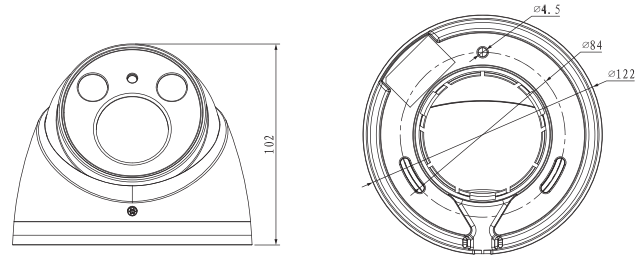

### Accessories (optional)



# DH-HAC-HDW2120R-VF

## 1.4Megapixel 720P Water-proof IR HDCVI Dome Camera



### Technical Specifications

Model	DH-HAC-HDW2120RP-VF	DH-HAC-HDW2120RN-VF
<b>Camera</b>		
Image Sensor	1/3" 1.4Megapixel CMOS	
Effective Pixels	1305(H)×1049(V)	
Electronic Shutter	1/3s~1/100,000s	
Video Frame Rate	25/50fps@720P	30/60fps@720P
Synchronization	Internal	
Mini. Illumination	0.01Lux@F1.2(AGC ON), 0Lux IR on	
Video Output	1-channel BNC HDCVI high definition video output/ CVBS standard definition video output (Can switch)	
<b>Camera Features</b>		
Max. IR LEDs Length	30m, Smart IR	
Day/Night	Auto(ICR) / Color / B/W	
Noise Reduction	2D/3D	
OSD Menu	Support	
<b>Lens</b>		
Focal Length	2.7~12mm	
Angle of View	H: 90°~28.7°	
Lens Type	Manual / Fixed Iris	
Mount Type	Φ14	
<b>General</b>		
Power Supply	DC12V±10%	
Power Consumption	Max 4.4W	
Working Environment	-30°C~+60°C / Less than 95%RH (no condensation)	
Transmission Distance	Over 800m via 75-3 coaxial cable	
Ingress Protection	IP67	
Dimensions	Φ119mm×97.4mm	
Weight	0.55kg	
Material	Metal	



### Features

- 1/3" 1.4Megapixel CMOS
- 25/30/50/60fps@720P
- High speed, long distance real-time transmission
- HD and standard definition switchable
- OSD Menu, control over coaxial cable
- DWDR, Day/Night(ICR), AWB, AGC, BLC, 3D-DNR
- 2.7~12mm vari-focal lens
- Max. IR LEDs length 30m, Smart IR
- IP67, DC12V

### Dimensions (mm)

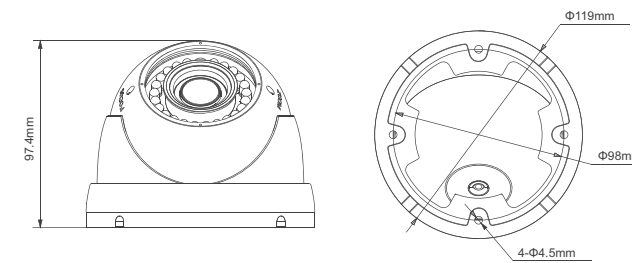

### Accessories (optional)



# DH-HAC-HFW2120D-B/HFW2120B-B

## 1.4Megapixel 720P Water-proof HDCVI IR-Bullet Camera



### Features

- 1/3" 1.4Megapixel CMOS
- 25/30/50/60fps@720P
- High speed, long distance real-time transmission
- HD and standard definition switchable
- OSD Menu, control over coaxial cable
- DWDR, Day/Night(ICR), AWB, AGC, BLC, 3D-DNR,
- 8mm fixed lens (3.6 mm, 6mm, 12mm, 16mm optional) (HFW2120D-B)
- 6mm fixed lens (2.8 mm, 3.6mm, 8mm optional) (HFW2120B-B)
- Max. IR LEDs length 80m(HFW2120D-B)/50m(HFW2120B-B), Smart IR
- IP67, DC12V

### Dimensions(mm)

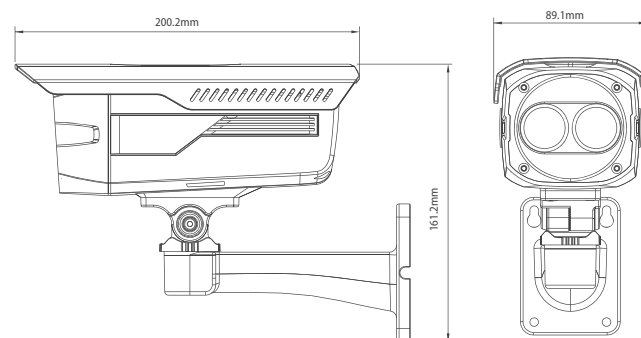

### Accessories (optional)



### Technical Specifications

Model	DH-HAC-HFW2120D/N-B	DH-HAC-HFW2120B/N-B
<b>Camera</b>		
Image Sensor	1/3" 1.4Megapixel CMOS	
Effective Pixels	1305(H)×1049(V)	
Electronic Shutter	1/3s~1/100,000s	
Video Frame Rate	25/30/50/60fps@720P	
Synchronization	Internal	
Min. Illumination	0.01Lux@F1.2(AGC ON), 0Lux IR on	
Video Output	1-channel BNC HDCVI high definition video output/ CVBS standard definition video output (Can switch)	
<b>Camera Features</b>		
Max. IR LEDs Length	80m, Smart IR	50m, Smart IR
Day/Night	Auto(ICR) / Color / B/W	
Noise Reduction	2D/3D	
OSD Menu	Support	
<b>Lens</b>		
Focal length	8mm fixed lens (3.6mm, 6mm, 12mm, 16mm optional)	6mm (3.6mm, 8mm optional)
Angle of View	H: 35°(70°/46.5°/22.4°/16.8°)	H: 46.5°(89°/70°/35°)
Mount Type	M12	
<b>General</b>		
Power Supply	DC12V±10%	
Power Consumption	Max 4.7W	Max 4.2W
Working Environment	-30°C~+60°C / Less than 95%RH (no condensation)	
Transmission Distance	Over 800m via 75-3 coaxial cable	
Ingress Protection	IP67	
Dimensions(W×D×H)	200.2mm×89.1mm×161.2mm	
Weight	0.58kg	
Material	Metal (front) + Plastic (body)	

# DH-HAC-HFW2120E NEW

## 1.4Megapixel 720P Water-proof HDCVI IR-Bullet Camera



### Features

- 1/3" 1.4Megapixel CMOS
- 25/30/50/60fps@720P
- High speed, long distance real-time transmission
- HD and standard definition switchable
- OSD Menu, control over coaxial cable
- DWDR, Day/Night(ICR), AWB, AGC, BLC, 3D-DNR
- 6mm fixed lens (2.8 mm, 3.6mm, 8mm optional)
- Max. IR LEDs length 40m, Smart IR
- IP67, DC12V

### Dimensions (mm)

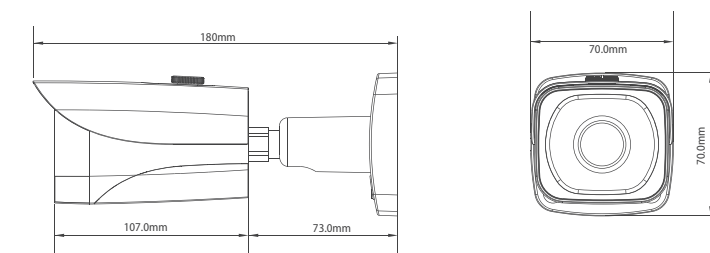

### Accessories (optional)



### Technical Specifications

Model	DH-HAC-HFW2120EP	DH-HAC-HFW2120EN
<b>Camera</b>		
Image Sensor	1/3" 1.4Megapixel CMOS	
Effective Pixels	1305(H)×1049(V)	
Electronic Shutter	1/3s~1/100,000s	
Video Frame Rate	25/50fps@720P	30/60fps@720P
Synchronization	Internal	
Mini. Illumination	0.01Lux@F1.2(AGC ON), 0Lux IR on	
Video Output	1-channel BNC HDCVI high definition video output/ CVBS standard definition video output (Can switch)	
<b>Camera Features</b>		
Max. IR LEDs Length	40m, Smart IR	
Day/Night	Auto(ICR)/ Color/ B/W	
Noise Reduction	2D/3D	
OSD Menu	Support	
<b>Lens</b>		
Focal Length	6mm (2.8mm, 3.6mm, 8mm optional)	
Angle of View	H: 46.5°(89°/70°/35°)	
Mount Type	M12	
<b>General</b>		
Power Supply	DC12V±10%	
Power Consumption	Max 5.3W	
Working Environment	-30°C~+60°C / Less than 95%RH (no condensation)	
Transmission Distance	Over 800m via 75-3 coaxial cable	
Ingress Protection	IP67	
Dimensions(W×D×H)	180mm×70.0mm×70.0mm	
Weight	0.4kg	
Material	Metal	

# DH-HAC-HFW2120S

## 1.4Megapixel 720P Water-proof HDCVI IR Bullet Camera



### Technical Specifications

Model	DH-HAC-HFW2120SP	DH-HAC-HFW2120SN
<b>Camera</b>		
Image Sensor	1/3" 1.4Megapixel CMOS	
Effective Pixels	1305(H)×1049(V)	
Electronic Shutter	1/3s~1/100,000s	
Video Frame Rate	25/50fps@720P	30/60fps@720P
Synchronization	Internal	
Min. Illumination	0.01Lux@F1.2(AGC ON), 0Lux IR on	
Video Output	1-channel BNC HDCVI high definition video output/ CVBS standard definition video output (Can switch)	
<b>Camera Features</b>		
Max. IR LEDs Length	30m, Smart IR	
Day/Night	Auto(ICR) / Color / B/W	
Noise Reduction	2D/3D	
OSD Menu	Support	
<b>Lens</b>		
Focal length	6mm (2.8mm, 3.6mm, 8mm optional)	
Angle of View	H: 46.5°(89°/70°/38.5°)	
Mount Type	M12	
<b>General</b>		
Power Supply	DC12V±10%	
Power Consumption	Max 4.7W	
Working Environment	-30°C~+60°C / Less than 95%RH (no condensation)	
Transmission Distance	Over 800m via 75-3 coaxial cable	
Ingress Protection	IP67	
Dimensions(W×D×H)	Φ65mm×154.7mm	
Weight	0.38kg	
Material	Metal	



### Features

- 1/3" 1.4Megapixel CMOS
- 25/30/50/60fps@720P
- High speed, long distance real-time transmission
- HD and standard definition switchable
- OSD Menu, control over coaxial cable
- DWDR, Day/Night(ICR), AWB, AGC, BLC, 3D-DNR
- 6mm fixed lens (2.8mm, 3.6mm, 8mm optional)
- Max. IR LEDs length 30m, Smart IR
- IP67, DC12V

### Dimensions(mm)

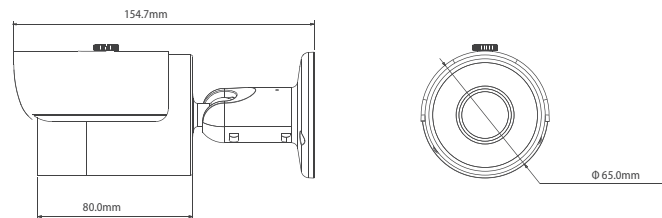

### Accessories (optional)



# DH-HAC-HDBW2120E

## 1.4Megapixel 720P Vandal-proof IR HDCVI Mini Dome Camera



### Technical Specifications

Model	DH-HAC-HDBW2120EP	DH-HAC-HDBW2120EN
<b>Camera</b>		
Image Sensor	1/3" 1.4Megapixel CMOS	
Effective Pixels	1305(H)×1049(V)	
Electronic Shutter	1/3s~1/100,000s	
Video Frame Rate	25/50fps@720P	30/60fps@720P
Synchronization	Internal	
Min. Illumination	0.01Lux@F1.2(AGC ON), 0Lux IR on	
Video Output	1-channel BNC HDCVI high definition video output/ CVBS standard definition video output (Can switch)	
<b>Camera Features</b>		
Max. IR LEDs Length	30m, Smart IR	
Day/Night	Auto(ICR) / Color / B/W	
Noise Reduction	2D/3D	
OSD Menu	Support	
<b>Lens</b>		
Focal Length	3.6mm (2.8mm, 6mm, 8mm optional)	
Angle of View	H: 70°(89°/46.5°/38.5°)	
Mount Type	M12	
<b>General</b>		
Power Supply	DC12V±10%	
Power Consumption	Max 3.5W	
Working Environment	-30°C~+60°C / Less than 95%RH (no condensation)	
Transmission Distance	Over 800m via 75-3 coaxial cable	
Ingress Protection	IP67 & IK10	
Dimensions(W×D×H)	Φ109.9mm×81.0mm	
Weight	0.3kg	
Material	Metal	



### Features

- 1/3" 1.4Megapixel CMOS
- 25/30/50/60fps@720P
- High speed, long distance real-time transmission
- HD and standard definition switchable
- OSD Menu, control over coaxial cable
- DWDR, Day/Night(ICR), AWB, AGC, BLC, 3D-DNR
- 3.6mm fixed lens (2.8mm, 6mm, 8mm optional)
- Max. IR LEDs length 30m, Smart IR
- IP67, IK10, DC12V

### Dimensions(mm)

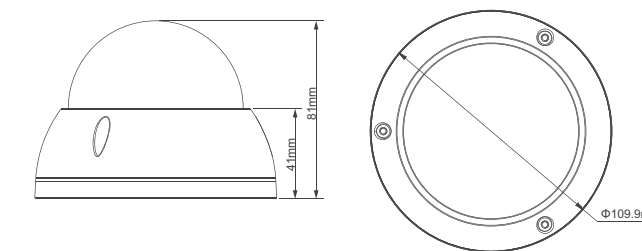

### Accessories (optional)



# DH-HAC-HDBW2120F NEW

## 1.4Megapixel 720P Vandal-proof IR HDCVI Mini Dome Camera



### Features

- 1/3" 1.4Megapixel CMOS
- 25/30/50/60fps@720P
- High speed, long distance real-time transmission
- HD and standard definition switchable
- OSD Menu, control over coaxial cable; Audio
- Day/Night(ICR), AWB, AGC, BLC, 3D-DNR
- 3.6mm fixed lens (6mm optional)
- Max. IR LEDs length 20m, Smart IR
- IP67, IK10, DC12V

### Dimensions(mm)

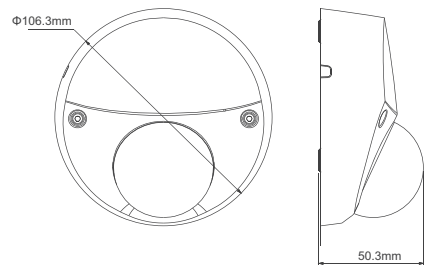

### Accessories (optional)



### Technical Specifications

Model	DH-HAC-HDBW2120FP	DH-HAC-HDBW2120FN
<b>Camera</b>		
Image Sensor	1/3" 1.4Megapixel CMOS	
Effective Pixels	1305(H)×1049(V)	
Electronic Shutter	1/3s~1/100,000s	
Video Frame Rate	25/50fps@720P	30/60fps@720P
Synchronization	Internal	
Min. Illumination	0.01Lux@F1.2(AGC ON), 0Lux IR on	
Video Output	1-channel BNC HDCVI high definition video output / CVBS standard definition video output (Can switch) Tester out (1-channel BNC HDCVI high definition video output / CVBS standard definition video output)	
<b>Camera Features</b>		
Max. IR LEDs Length	20m, Smart IR	
Day/Night	Auto(ICR) / Color / B/W	
Noise Reduction	2D/3D	
OSD Menu	Support	
<b>Lens</b>		
Focal Length	3.6mm (6mm optional)	
Angle of View	H: 88°(53.4°)	
Mount Type	M12	
<b>General</b>		
Power Supply	DC12V±10%	
Power Consumption	Max 3.2W	
Working Environment	-30°C~+60°C / Less than 95%RH (no condensation)	
Transmission Distance	Over 800m via 75-3 coaxial cable	
Ingress Protection	IP67 & IK10	
Dimensions(W×D×H)	Φ106.3mm×50.3mm	
Weight	0.28kg	
Material	Metal	
Others	With pickup	

# DH-HAC-HDW2120E NEW

## 1.4Megapixel 720P Water-proof IR HDCVI Dome Camera



### Features

- 1/3" 1.4Megapixel CMOS
- 25/30/50/60fps@720P
- High speed, long distance real-time transmission
- HD and standard definition switchable
- OSD Menu, control over coaxial cable
- DWDR, Day/Night(ICR), AWB, AGC, BLC, 3D-DNR
- 3.6mm fixed lens (2.8mm, 6mm, 8mm optional)
- Max. IR LEDs length 50m, Smart IR
- IP67, DC12V

### Dimensions(mm)

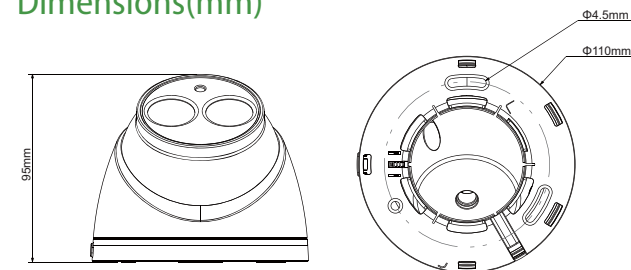

### Accessories (optional)



### Technical Specifications

Model	DH-HAC-HDW2120EP	DH-HAC-HDW2120EN
<b>Camera</b>		
Image Sensor	1/3" 1.4Megapixel CMOS	
Effective Pixels	1305(H)×1049(V)	
Electronic Shutter	1/3s~1/100,000s	
Video Frame Rate	25/50fps@720P	30/60fps@720P
Synchronization	Internal	
Min. Illumination	0.01Lux@F1.2(AGC ON), 0Lux IR on	
Video Output	1-channel BNC HDCVI high definition video output/ CVBS standard definition video output (Can switch)	
<b>Camera Features</b>		
Max. IR LEDs Length	50m, Smart IR	
Day/Night	Auto(ICR) / Color / B/W	
Noise Reduction	2D/3D	
OSD Menu	Support	
<b>Lens</b>		
Focal Length	3.6mm (2.8mm, 6mm, 8mm optional)	
Angle of View	H: 70°(89°/46.5°/38.5°)	
Mount Type	M12	
<b>General</b>		
Power Supply	DC12V±10%	
Power Consumption	Max 4W	
Working Environment	-30°C~+60°C / Less than 95%RH (no condensation)	
Transmission Distance	Over 800m via 75-3 coaxial cable	
Ingress Protection	IP67	
Dimensions(W×D×H)	Φ110mm×95mm	
Weight	0.3kg	
Material	Metal	

# DH-HAC-HDW2120M

## 1.4Megapixel 720P Water-proof IR HDCVI Mini Dome Camera



### Features

- 1/3" 1.4Megapixel CMOS
- 25/30/50/60fps@720P
- High speed, long distance real-time transmission
- HD and standard definition switchable
- OSD Menu, control over coaxial cable
- DWDR, Day/Night(ICR), AWB, AGC, BLC, 3D-DNR
- 3.6mm fixed lens (2.8mm, 6mm, 8mm optional)
- Max. IR LEDs length 30m, Smart IR
- IP67, DC12V

### Dimensions(mm)

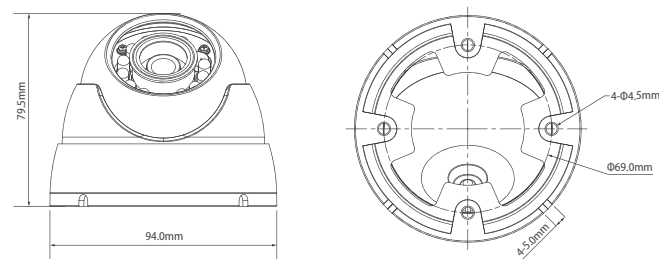

### Accessories (optional)



### Technical Specifications

Model	DH-HAC-HDW2120MP	DH-HAC-HDW2120MN
<b>Camera</b>		
Image Sensor	1/3" 1.4Megapixel CMOS	
Effective Pixels	1305(H)×1049(V)	
Electronic Shutter	1/3s~1/100,000s	
Video Frame Rate	25/50fps@720P	30/60fps@720P
Synchronization	Internal	
Min. Illumination	0.01Lux@F1.2(AGC ON), 0Lux IR on	
Video Output	1-channel BNC HDCVI high definition video output/ CVBS standard definition video output (Can switch)	
<b>Camera Features</b>		
Max. IR LEDs Length	30m, Smart IR	
Day/Night	Auto(ICR) / Color / B/W	
Noise Reduction	2D/3D	
OSD Menu	Support	
<b>Lens</b>		
Focal Length	3.6mm (2.8mm, 6mm, 8mm optional)	
Angle of View	H: 70°(89°/46.5°/35°)	
Mount Type	M12	
<b>General</b>		
Power Supply	DC12V±10%	
Power Consumption	Max 3.3W	
Working Environment	-30°C~+60°C / Less than 95%RH (no condensation)	
Transmission Distance	Over 800m via 75-3 coaxial cable	
Ingress Protection	IP67	
Dimensions	Φ94.0mm×79.5mm	
Weight	0.35kg	
Material	Metal	

# DH-HAC-HDW2120S

## 1.4Megapixel 720P Water-proof IR HDCVI Mini Dome Camera



### Features

- 1/3" 1.4Megapixel CMOS
- 25/30/50/60fps@720P
- High speed, long distance real-time transmission
- HD and standard definition switchable
- OSD Menu, control over coaxial cable
- DWDR, Day/Night(ICR), AWB, AGC, BLC, 3D-DNR
- 6mm fixed lens (2.8 mm, 3.6mm, 8mm optional)
- Max. IR LEDs length 30m, Smart IR
- IP67, DC12V

### Dimensions(mm)

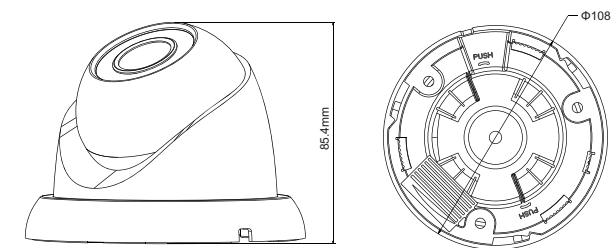

### Accessories (optional)



### Technical Specifications

Model	DH-HAC-HDW2120SP	DH-HAC-HDW2120SN
<b>Camera</b>		
Image Sensor	1/3" 1.4Megapixel CMOS	
Effective Pixels	1305(H)×1049(V)	
Electronic Shutter	1/3s~1/100,000s	
Video Frame Rate	25/50fps@720P	30/60fps@720P
Synchronization	Internal	
Min. Illumination	0.01Lux@F1.2(AGC ON), 0Lux IR on	
Video Output	1-channel BNC HDCVI high definition video output/ CVBS standard definition video output (Can switch)	
<b>Camera Features</b>		
Max. IR LEDs Length	30m, Smart IR	
Day/Night	Auto(ICR) / Color / B/W	
Noise Reduction	2D/3D	
OSD Menu	Support	
<b>Lens</b>		
Focal Length	3.6mm (2.8mm, 6mm, 8mm optional)	
Angle of View	H: 70°(89°/46.5°/35°)	
Mount Type	M12	
<b>General</b>		
Power Supply	DC12V±10%	
Power Consumption	Max 3.3W	
Working Environment	-30°C~+60°C / Less than 95%RH (no condensation)	
Transmission Distance	Over 800m via 75-3 coaxial cable	
Ingress Protection	IP67	
Dimensions	Φ108mm×85.4mm	
Weight	0.35kg	
Material	Metal(inner core) + Plastic(outside)	



# DH-HAC-HFW1100R-VF

1Megapixel 720P Water-proof HDCVI IR-Bullet Camera



## Technical Specifications

Model	DH-HAC-HFW1100RP-VF	DH-HAC-HFW1100RN-VF
<b>Camera</b>		
Image Sensor	1/2.9" 1Megapixel CMOS	
Effective Pixels	1280(H)×720(V)	
Electronic Shutter	1/50s~1/100,000s	1/60s~1/100,000s
Video Frame Rate	25fps@720P	30fps@720P
Synchronization	Internal	
Min. Illumination	0.01Lux@F1.2(AGC ON), 0Lux IR on	
Video Output	1-channel BNC HDCVI high definition video output	
<b>Camera Features</b>		
Max. IR LEDs Length	30m, Smart IR	
Day/Night	Auto(ICR) / Color / B/W	
Noise Reduction	2D	
<b>Lens</b>		
Focal Length	2.7~12mm	
Angle of View	H: 105.5°~32.9°	
Lens Type	Manual / Fixed Iris	
Mount Type	Φ14	
<b>General</b>		
Power Supply	DC12V±10%	
Power Consumption	Max 3.2W	
Working Environment	-30°C~+60°C / Less than 95%RH (no condensation)	
Transmission Distance	Over 800m via 75-3 coaxial cable	
Ingress Protection	IP67	
Dimensions(W×D×H)	213mm×80mm×72mm	
Weight	0.55kg	
Material	Metal	



## Features

- 1/2.9" 1Megapixel CMOS
- 25/30fps@720P
- High speed, long distance real-time transmission
- Day/Night(ICR), AWB, AGC, BLC, 2D-DNR
- 2.7~12mm vari-focal lens
- Max. IR LEDs length 30m, Smart IR
- IP67, DC12V

## Dimensions (mm)

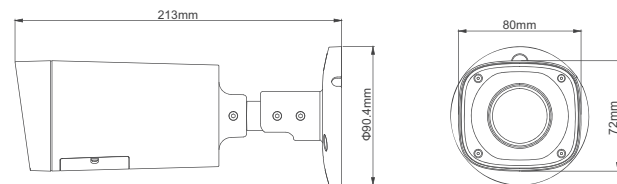

## Accessories (optional)



# DH-HAC-HDBW1100R-VF

1Megapixel 720P Vandal-proof IR HDCVI Dome Camera



## Technical Specifications

Model	DH-HAC-HDBW1100RP-VF	DH-HAC-HDBW1100RN-VF
<b>Camera</b>		
Image Sensor	1/2.9" 1Megapixel CMOS	
Effective Pixels	1280(H)×720(V)	
Electronic Shutter	1/50s~1/100,000s	1/60s~1/100,000s
Video Frame Rate	25fps@720P	30fps@720P
Synchronization	Internal	
Min. Illumination	0.01Lux@F1.2(AGC ON), 0Lux IR on	
Video Output	1-channel BNC HDCVI high definition video output	
<b>Camera Features</b>		
Max. IR LEDs Length	30m, Smart IR	
Day/Night	Auto(ICR) / Color / B/W	
Noise Reduction	2D	
<b>Lens</b>		
Focal Length	2.7~12mm	
Angle of View	H: 105.5°~32.9°	
Lens Type	Manual / Fixed Iris	
Mount Type	Φ14	
<b>General</b>		
Power Supply	DC12V±10%	
Power Consumption	Max 3.2W	
Working Environment	-30°C~+60°C / Less than 95%RH (no condensation)	
Transmission Distance	Over 800m via 75-3 coaxial cable	
Ingress Protection	IP67 & IK10	
Dimensions	Φ122mm×89mm	
Weight	0.45kg	
Material	Metal	



## Features

- 1/2.9" 1Megapixel CMOS
- 25/30fps@720P
- High speed, long distance real-time transmission
- Day/Night(ICR), AWB, AGC, BLC, 2D-DNR
- 2.7~12mm vari-focal lens
- Max. IR LEDs length 30m, Smart IR
- IP67, IK10, DC12V

## Dimensions(mm)

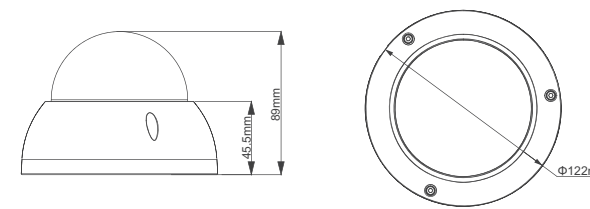

## Accessories (optional)



# DH-HAC-HDW1100R-VF

## 1Megapixel 720P Water-proof IR HDCVI Dome Camera



### Technical Specifications

Model	DH-HAC-HDW1100RP-VF	DH-HAC-HDW1100RN-VF
<b>Camera</b>		
Image Sensor	1/2.9" 1Megapixel CMOS	
Effective Pixels	1280(H)×720(V)	
Electronic Shutter	1/50s~1/100,000s	1/60s~1/100,000s
Video Frame Rate	25fps@720P	30fps@720P
Synchronization	Internal	
Min. Illumination	0.01Lux@F1.2(AGC ON), 0Lux IR on	
Video Output	1-channel BNC HDCVI high definition video output	
<b>Camera Features</b>		
Max. IR LEDs Length	30m, Smart IR	
Day/Night	Auto(ICR) / Color / B/W	
Noise Reduction	2D	
<b>Lens</b>		
Focal Length	2.7~12mm	
Angle of View	H: 105.5°~32.9°	
Lens Type	Manual / Fixed Iris	
Mount Type	Φ14	
<b>General</b>		
Power Supply	DC12V±10%	
Power Consumption	Max 2.8W	
Working Environment	-30°C~+60°C / Less than 95%RH (no condensation)	
Transmission Distance	Over 800m via 75-3 coaxial cable	
Ingress Protection	IP67	
Dimensions	Φ119mm×97.4mm	
Weight	0.55kg	
Material	Metal	



### Features

- 1/2.9" 1Megapixel CMOS
- 25/30fps@720P
- High speed, long distance real-time transmission
- Day/Night(ICR), AWB, AGC, BLC, 2D-DNR
- 2.7~12mm vari-focal lens
- Max. IR LEDs length 30m, Smart IR
- IP67, DC12V

### Dimensions (mm)

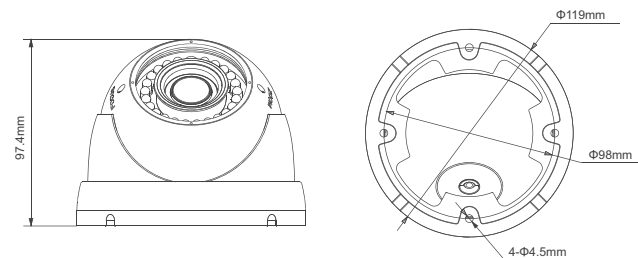

### Accessories (optional)



# DH-HAC-HFW1100D-B/HFW1100B-B

## 1Megapixel 720P Water-proof HDCVI IR Bullet Camera



### Technical Specifications

Model	DH-HAC-HFW1100DP/N-B	DH-HAC-HFW1100BP/N-B
<b>Camera</b>		
Image Sensor	1/2.9" 1Megapixel CMOS	
Effective Pixels	1280(H)×720(V)	
Electronic Shutter	1/50s(60s)~1/100,000s	
Video Frame Rate	25/30fps@720P	
Synchronization	Internal	
Min. Illumination	0.01Lux@F1.2(AGC ON), 0Lux IR LED on	
Video Output	1-channel BNC HDCVI high definition video output	
<b>Camera Features</b>		
Max. IR LEDs Length	80m, Smart IR	50m, Smart IR
Day/Night	Auto(ICR) / Color / B/W	
Noise Reduction	2D	
<b>Lens</b>		
Focal length	8mm fixed lens (3.6mm, 6mm, 12mm, 16mm optional)	6mm (3.6mm, 8mm optional)
Angle of View	H: 39.9°(79.7°/52.2°/25.2°/18.7°)	H: 52.2°(103.4°/79.7°/39.9°)
Mount Type	M12	
<b>General</b>		
Power Supply	DC12V±10%	
Power Consumption	Max 7W	Max 4.9W
Working Environment	-30°C~+60°C / Less than 95%RH (no condensation)	
Transmission Distance	Over 800m via 75-3 coaxial cable	
Ingress Protection	IP67	
Dimensions(W×D×H)	200.2mm×89.1mm×161.2mm	
Weight	0.58kg	
Material	Metal (front) + Plastic (body)	



### Features

- 1/2.9" 1Megapixel CMOS
- 25/30fps@720P
- High speed, long distance real-time transmission
- Day/Night(ICR), AWB, AGC, BLC, 2D-DNR,
- 8mm fixed lens (3.6 mm, 6mm, 12mm, 16mm optional) (HFW1100D-B)
- 6mm fixed lens (2.8 mm, 3.6mm, 8mm optional) (HFW1100B-B)
- Max. IR LEDs length 80m(HFW1100D-B)/50m(HFW1100B-B), Smart IR
- IP67, DC12V

### Dimensions(mm)

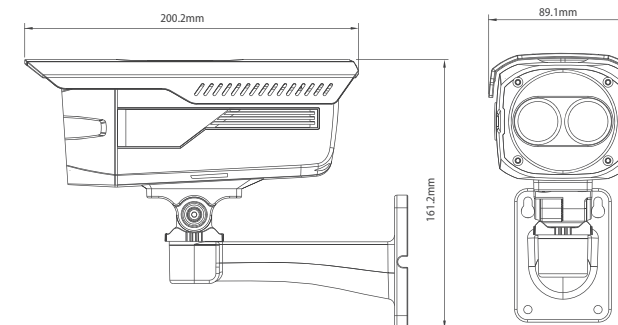

### Accessories (optional)



# DH-HAC-HFW1100S

1Megapixel 720P Water-proof HDCVI IR-Bullet Camera

## Technical Specifications

Model	DH-HAC-HFW1100SP	DH-HAC-HFW1100SN
<b>Camera</b>		
Image Sensor	1/2.9" 1Megapixel CMOS	
Effective Pixels	1280(H)×720(V)	
Electronic Shutter	1/50s~1/100,000s	1/60s~1/100,000s
Video Frame Rate	25fps@720P	30fps@720P
Synchronization	Internal	
Min. Illumination	0.01Lux@F1.2 (AGC ON), 0Lux IR LED on	
Video Output	1-channel BNC HDCVI high definition video output	
<b>Camera Features</b>		
Max. IR LEDs Length	30m, Smart IR	
Day/Night	Auto(ICR) / Color / B/W	
Noise Reduction	2D	
<b>Lens</b>		
Focal length	6mm (2.8 mm, 3.6mm, 8mm optional)	
Angle of View	H: 52.2°(103.4°/79.7°/39.9°)	
Mount Type	M12	
<b>General</b>		
Power Supply	DC12V±10%	
Power Consumption	Max 3.5W	
Working Environment	-30°C~+60°C / Less than 95%RH (no condensation)	
Transmission Distance	Over 800m via 75-3 coaxial cable	
Ingress Protection	IP67	
Dimensions(W×D×H)	Φ70mm×165mm	
Weight	0.35kg	
Material	Metal (body) + Plastic (sunshield)	



## Features

- 1/2.9" 1Megapixel CMOS
- 25/30fps@720P
- High speed, long distance real-time transmission
- Day/Night(ICR), AWB, AGC, BLC, 2D-DNR
- 6mm fixed lens (2.8 mm, 3.6mm, 8mm optional)
- Max. IR LEDs length 30m, Smart IR
- IP67, DC12V

## Dimensions (mm)

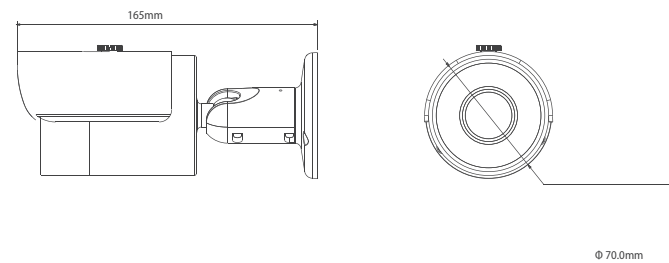

## Accessories (optional)



# DH-HAC-HFW1100RM NEW

1Megapixel 720P Water-proof HDCVI IR-Bullet Camera

## Technical Specifications

Model	DH-HAC-HFW1100RMP	DH-HAC-HFW1100RMN
<b>Camera</b>		
Image Sensor	1/2.9" 1Megapixel CMOS	
Effective Pixels	1280(H)×720(V)	
Electronic Shutter	1/50s~1/100,000s	1/60s~1/100,000s
Video Frame Rate	25fps@720P	30fps@720P
Synchronization	Internal	
Min. Illumination	0.01Lux@F1.2(AGC ON), 0Lux IR on	
Video Output	1-channel BNC HDCVI high definition video output	
<b>Camera Features</b>		
Max. IR LEDs Length	20m, Smart IR	
Day/Night	Auto(ICR) / Color / B/W	
Noise Reduction	2D	
<b>Lens</b>		
Focal Length	6mm fixed lens (3.6mm optional)	
Angle of View	H: 52.2°(79.7°)	
Mount Type	M12	
<b>General</b>		
Power Supply	DC12V±10%	
Power Consumption	Max 3.5W	
Working Environment	-30°C~+60°C / Less than 95%RH (no condensation)	
Transmission Distance	Over 800m via 75-3 coaxial cable	
Ingress Protection	IP67	
Dimensions(W×D×H)	Φ70mm×154mm	
Weight	0.3kg	
Material	Metal	



## Features

- 1/2.9" 1Megapixel CMOS
- 25/30fps@720P
- High speed, long distance real-time transmission
- Day/Night(ICR), AWB, AGC, BLC, 2D-DNR
- 6mm fixed lens (3.6mm optional)
- Max. IR LEDs length 20m, Smart IR
- IP67, DC12V

## Dimensions (mm)

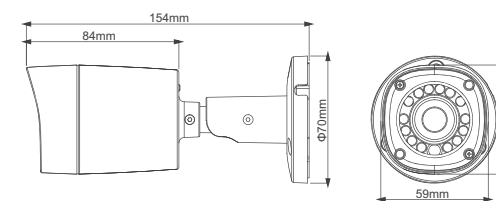

## Accessories (optional)



# DH-HAC-HFW1100R

1 Megapixel 720P Water-proof HDCVI IR-Bullet Camera



## Technical Specifications

Model	DH-HAC-HFW1100RP	DH-HAC-HFW1100RN
<b>Camera</b>		
Image Sensor	1/2.9" 1Megapixel CMOS	
Effective Pixels	1280(H)×720(V)	
Electronic Shutter	1/50s~1/100,000s	1/60s~1/100,000s
Video Frame Rate	25fps@720P	30fps@720P
Synchronization	Internal	
Min. Illumination	0.01Lux@F1.2(AGC ON), 0Lux IR on	
Video Output	1-channel BNC HDCVI high definition video output	
<b>Camera Features</b>		
Max. IR LEDs Length	20m, Smart IR	
Day/Night	Auto(ICR) / Color / B/W	
Noise Reduction	2D	
<b>Lens</b>		
Focal Length	6mm (3.6mm optional)	
Angle of View	H: 52.2°(79.7°)	
Mount Type	M12	
<b>General</b>		
Power Supply	DC12V±10%	
Power Consumption	Max 2.2W	
Working Environment	-30°C~+60°C / Less than 95%RH (no condensation)	
Transmission Distance	Over 800m via 75-3 coaxial cable	
Ingress Protection	IP67	
Dimensions(W×D×H)	Φ70mm×154mm	
Weight	0.15kg	
Material	Plastic	



## Features

- 1/2.9" 1Megapixel CMOS
- 25/30fps@720P
- High speed, long distance real-time transmission
- Day/Night(ICR), AWB, AGC, BLC, 2D-DNR
- 6mm fixed lens (3.6mm optional)
- Max. IR LEDs length 20m, Smart IR
- IP67, DC12V

## Dimensions(mm)

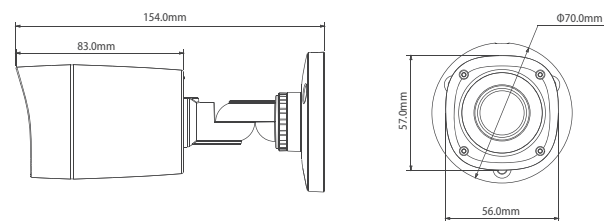

## Accessories (optional)



# DH-HAC-HDBW1100E NEW

1 Megapixel 720P Vandal-proof IR HDCVI Mini Dome Camera



## Technical Specifications

Model	DH-HAC-HDBW1100EP	DH-HAC-HDBW1100EN
<b>Camera</b>		
Image Sensor	1/2.9" 1Megapixel CMOS	
Effective Pixels	1280(H)×720(V)	
Electronic Shutter	1/50s~1/100,000s	1/60s~1/100,000s
Video Frame Rate	25fps@720P	30fps@720P
Synchronization	Internal	
Min. Illumination	0.01Lux@F1.2(AGC ON), 0Lux IR on	
Video Output	1-channel BNC HDCVI high definition video output	
<b>Camera Features</b>		
Max. IR LEDs Length	30m, Smart IR	
Day/Night	Auto(ICR) / Color / B/W	
Noise Reduction	2D	
<b>Lens</b>		
Focal Length	3.6mm (2.8mm, 6mm, 8mm optional)	
Angle of View	H: 79.7°(103.4°/52.2°/39.9°)	
Mount Type	M12	
<b>General</b>		
Power Supply	DC12V±10%	
Power Consumption	Max 2.5W	
Working Environment	-30°C~+60°C / Less than 95%RH (no condensation)	
Transmission Distance	Over 800m via 75-3 coaxial cable	
Ingress Protection	IP67 & IK10	
Dimensions(W×D×H)	Φ110mm×81.0mm	
Weight	0.3kg	
Material	Metal	



## Features

- 1/2.9" 1Megapixel CMOS
- 25/30fps@720P
- High speed, long distance real-time transmission
- Day/Night(ICR), AWB, AGC, BLC, 2D-DNR
- 3.6mm fixed lens (2.8mm, 6mm, 8mm optional)
- Max. IR LEDs length 30m, Smart IR
- IP67, IK10, DC12V

## Dimensions(mm)

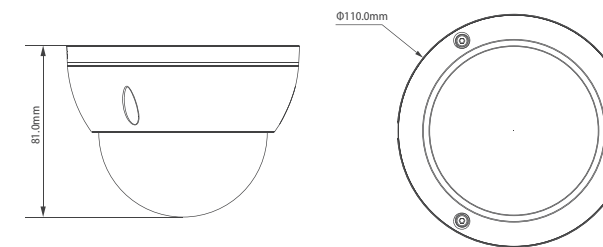

## Accessories (optional)



# DH-HAC-HDW1100M

1Megapixel 720P Water-proof IR HDCVI Mini Dome Camera



## Features

- 1/2.9" 1Megapixel CMOS
- 25/30fps@720P
- High speed, long distance real-time transmission
- Day/Night(ICR), AWB, AGC, BLC, 2D-DNR
- 3.6mm fixed lens (2.8mm, 6mm, 8mm optional)
- Max. IR LEDs length 30m, Smart IR
- IP67, DC12V

## Dimensions(mm)

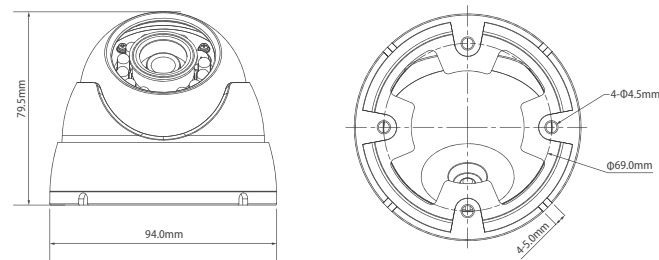

## Accessories (optional)



## Technical Specifications

Model	DH-HAC-HDW1100MP	DH-HAC-HDW1100MN
<b>Camera</b>		
Image Sensor	1/2.9" 1Megapixel CMOS	
Effective Pixels	1280(H)×720(V)	
Electronic Shutter	1/50s~1/100,000s	1/60s~1/100,000s
Video Frame Rate	25fps@720P	30fps@720P
Synchronization	Internal	
Min. Illumination	0.01Lux@F1.2(AGC ON), 0Lux IR on	
Video Output	1-channel BNC HDCVI high definition video output	
<b>Camera Features</b>		
Max. IR LEDs Length	30m, Smart IR	
Day/Night	Auto(ICR) / Color / B/W	
Noise Reduction	2D	
<b>Lens</b>		
Focal Length	3.6mm (2.8mm, 6mm, 8mm optional)	
Angle of View	H: 79.7°(103.4°/52.2°/39.9°)	
Mount Type	M12	
<b>General</b>		
Power Supply	DC12V±10%	
Power Consumption	Max 2.5W	
Working Environment	-30°C~+60°C / Less than 95%RH (no condensation)	
Transmission Distance	Over 800m via 75-3 coaxial cable	
Ingress Protection	IP67	
Dimensions	Ø94.0mm×79.5mm	
Weight	0.35kg	
Material	Metal	

# DH-HAC-HDW1100R

1Megapixel 720P IR HDCVI Mini Dome Camera



## Features

- 1/2.9" 1Megapixel CMOS
- 25/30fps@720P
- High speed, long distance real-time transmission
- Day/Night(ICR), AWB, AGC, BLC, 2D-DNR
- 3.6mm fixed lens (6mm optional)
- Max. IR LEDs length 20m, Smart IR
- DC12V

## Dimensions(mm)

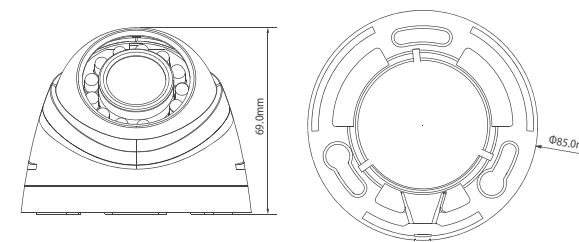

## Accessories (optional)



## Technical Specifications

Model	DH-HAC-HDW1100RP	DH-HAC-HDW1100RN
<b>Camera</b>		
Image Sensor	1/2.9" 1Megapixel CMOS	
Effective Pixels	1280(H)×720(V)	
Electronic Shutter	1/50s~1/100,000s	1/60s~1/100,000s
Video Frame Rate	25fps@720P	30fps@720P
Synchronization	Internal	
Min. Illumination	0.01Lux@F1.2(AGC ON), 0Lux IR on	
Video Output	1-channel BNC HDCVI high definition video output	
<b>Camera Features</b>		
Max. IR LEDs Length	20m, Smart IR	
Day/Night	Auto(ICR) / Color / B/W	
Noise Reduction	2D	
<b>Lens</b>		
Focal Length	3.6mm (6mm optional)	
Angle of View	H: 79.7°(52.2°)	
Mount Type	M12	
<b>General</b>		
Power Supply	DC12V±10%	
Power Consumption	Max 2.2W	
Working Environment	-30°C~+60°C / Less than 95%RH (no condensation)	
Transmission Distance	Over 800m via 75-3 coaxial cable	
Dimensions	Ø85mm×69mm	
Weight	0.1kg	
Material	Plastic	

# DH-HAC-HFW1000S NEW

## 1Megapixel 720P Water-proof HDCVI IR-Bullet Camera

### Technical Specifications

Model	DH-HAC-HFW1000SP	DH-HAC-HFW1000SN
<b>Camera</b>		
Image Sensor	1/4" 1Megapixel CMOS	
Effective Pixels	1280(H)×720(V)	
Electronic Shutter	1/50s~1/100,000s	1/60s~1/100,000s
Video Frame Rate	25fps@720P	30fps@720P
Synchronization	Internal	
Min. Illumination	0.01Lux@F1.2(AGC ON), 0Lux IR on	
Video Output	1-channel BNC HDCVI high definition video output	
<b>Camera Features</b>		
Max. IR LEDs Length	30m, Smart IR	
Day/Night	Auto(ICR) / Color / B/W	
Noise Reduction	2D	
<b>Lens</b>		
Focal length	3.6mm fixed lens	
Angle of View	H: 59°	
Mount Type	M12	
<b>General</b>		
Power Supply	DC12V±20%	
Power Consumption	Max 3.5W	
Working Environment	-30°C~+60°C / Less than 95%RH (no condensation)	
Transmission Distance	Over 800m via 75-3 coaxial cable	
Ingress Protection	IP67	
Dimensions(W×D×H)	Φ70mm×165mm	
Weight	0.35kg	
Material	Metal (body) + Plastic (sunshield)	



### Features

- 1/4" 1Megapixel CMOS
- 25/30fps@720P
- High speed, long distance real-time transmission
- Day/Night(ICR), AWB, AGC, BLC, 2D-DNR
- 3.6mm fixed lens
- Max. IR LEDs length 30m, Smart IR
- IP67, DC12V

### Dimensions (mm)

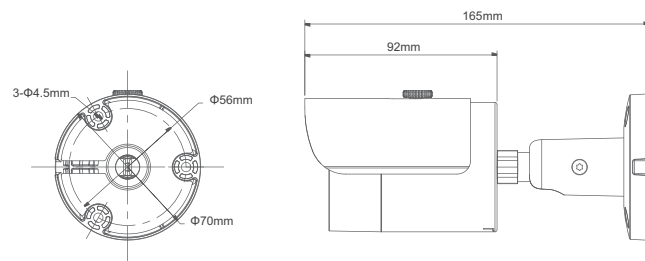

### Accessories (optional)



# DH-HAC-HFW1000RM NEW

## 1Megapixel 720P Water-proof HDCVI IR-Bullet Camera

### Technical Specifications

Model	DH-HAC-HFW1000RMP	DH-HAC-HFW1000RMN
<b>Camera</b>		
Image Sensor	1/4" 1Megapixel CMOS	
Effective Pixels	1280(H)×720(V)	
Electronic Shutter	1/50s~1/100,000s	1/60s~1/100,000s
Video Frame Rate	25fps@720P	30fps@720P
Synchronization	Internal	
Min. Illumination	0.01Lux@F1.2(AGC ON), 0Lux IR on	
Video Output	1-channel BNC HDCVI high definition video output	
<b>Camera Features</b>		
Max. IR LEDs Length	20m, Smart IR	
Day/Night	Auto(ICR) / Color / B/W	
Noise Reduction	2D	
<b>Lens</b>		
Focal Length	3.6mm fixed lens	
Angle of View	H: 59°	
Mount Type	M12	
<b>General</b>		
Power Supply	DC12V±20%	
Power Consumption	Max 3.5W	
Working Environment	-30°C~+60°C / Less than 95%RH (no condensation)	
Transmission Distance	Over 800m via 75-3 coaxial cable	
Ingress Protection	IP67	
Dimensions(W×D×H)	Φ70mm×154mm	
Weight	0.3kg	
Material	Metal	



### Features

- 1/4" 1Megapixel CMOS
- 25/30fps@720P
- High speed, long distance real-time transmission
- Day/Night(ICR), AWB, AGC, BLC, 2D-DNR
- 3.6mm fixed lens
- Max. IR LEDs length 20m, Smart IR
- IP67, DC12V

### Dimensions(mm)

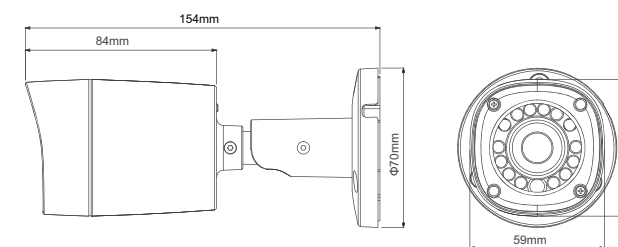

### Accessories (optional)



# DH-HAC-HFW1000R NEW

## 1 Megapixel 720P Water-proof HDCVI IR-Bullet Camera



### Technical Specifications

Model	DH-HAC-HFW1000RP	DH-HAC-HFW1000RN
<b>Camera</b>		
Image Sensor	1/4" 1Megapixel CMOS	
Effective Pixels	1280(H)×720(V)	
Electronic Shutter	1/50s~1/100,000s	1/60s~1/100,000s
Video Frame Rate	25fps@720P	30fps@720P
Synchronization	Internal	
Min. Illumination	0.01Lux@F1.2(AGC ON), 0Lux IR on	
Video Output	1-channel BNC HDCVI high definition video output	
<b>Camera Features</b>		
Max. IR LEDs Length	20m, Smart IR	
Day/Night	Auto(ICR) / Color / B/W	
Noise Reduction	2D	
<b>Lens</b>		
Focal length	3.6mm fixed lens	
Angle of View	H: 59°	
Mount Type	M12	
<b>General</b>		
Power Supply	DC12V±20%	
Power Consumption	Max 3.5W	
Working Environment	-30°C~+60°C / Less than 95%RH (no condensation)	
Transmission Distance	Over 800m via 75-3 coaxial cable	
Ingress Protection	IP67	
Dimensions(W×D×H)	Φ70mm×154mm	
Weight	0.2kg	
Material	Plastic	



### Features

- 1/4" 1Megapixel CMOS
- 25/30fps@720P
- High speed, long distance real-time transmission
- Day/Night(ICR), AWB, AGC, BLC, 2D-DNR
- 3.6mm fixed lens
- Max. IR LEDs length 20m, Smart IR
- IP67, DC12V

### Dimensions(mm)

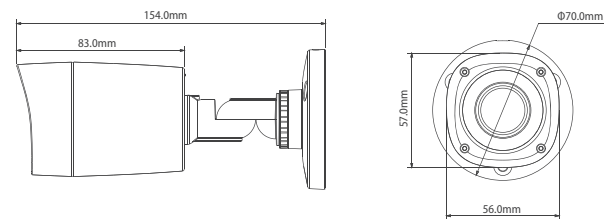

### Accessories (optional)



# DH-HAC-HDW1000M NEW

## 1 Megapixel 720P Water-proof IR HDCVI Mini Dome Camera



### Technical Specifications

Model	DH-HAC-HDW1000MP	DH-HAC-HDW1000MN
<b>Camera</b>		
Image Sensor	1/4" 1Megapixel CMOS	
Effective Pixels	1280(H)×720(V)	
Electronic Shutter	1/50s~1/100,000s	1/60s~1/100,000s
Video Frame Rate	25fps@720P	30fps@720P
Synchronization	Internal	
Min. Illumination	0.01Lux@F1.2(AGC ON), 0Lux IR on	
Video Output	1-channel BNC HDCVI high definition video output	
<b>Camera Features</b>		
Max. IR LEDs Length	30m, Smart IR	
Day/Night	Auto(ICR) / Color / B/W	
Noise Reduction	2D	
<b>Lens</b>		
Focal Length	3.6mm fixed lens	
Angle of View	H: 59°	
Mount Type	M12	
<b>General</b>		
Power Supply	DC12V±20%	
Power Consumption	Max 2.5W	
Working Environment	-30°C~+60°C / Less than 95%RH (no condensation)	
Transmission Distance	Over 800m via 75-3 coaxial cable	
Ingress Protection	IP67	
Dimensions	Φ94.0mm×79.5mm	
Weight	0.35kg	
Material	Metal	



### Features

- 1/4" 1Megapixel CMOS
- 25/30fps@720P
- High speed, long distance real-time transmission
- Day/Night(ICR), AWB, AGC, BLC, 2D-DNR
- 3.6mm fixed lens
- Max. IR LEDs length 30m, Smart IR
- IP67, DC12V

### Dimensions(mm)

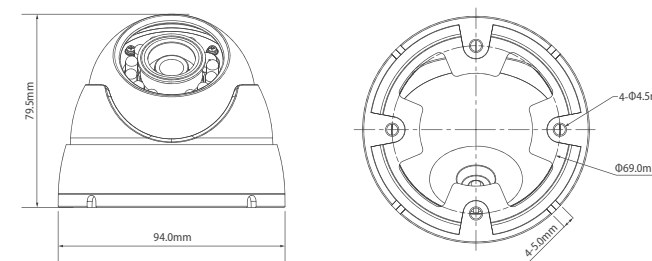

### Accessories (optional)



# DH-HAC-HDW1000R **NEW**



1Megapixel 720P IR HDCVI Mini Dome Camera



## Technical Specifications

Model	DH-HAC-HDW1000RP	DH-HAC-HDW1000RN
<b>Camera</b>		
Image Sensor	1/4" 1Megapixel CMOS	
Effective Pixels	1280(H)×720(V)	
Electronic Shutter	1/50s~1/100,000s	1/60s~1/100,000s
Video Frame Rate	25fps@720P	30fps@720P
Synchronization	Internal	
Min. Illumination	0.01Lux@F1.2(AGC ON), 0Lux IR on	
Video Output	1-channel BNC HDCVI high definition video output	
<b>Camera Features</b>		
Max. IR LEDs Length	20m, Smart IR	
Day/Night	Auto(ICR) / Color / B/W	
Noise Reduction	2D	
<b>Lens</b>		
Focal length	3.6mm fixed lens	
Angle of View	H: 59°	
Mount Type	M12	
<b>General</b>		
Power Supply	DC12V±20%	
Power Consumption	Max 2.5W	
Working Environment	-30°C~+60°C / Less than 95%RH (no condensation)	
Transmission Distance	Over 800m via 75-3 coaxial cable	
Dimensions	Φ85mm×69mm	
Weight	0.1kg	
Material	Plastic	



## Features

- 1/4" 1Megapixel CMOS
- 25/30fps@720P
- High speed, long distance real-time transmission
- Day/Night(ICR), AWB, AGC, BLC, 2D-DNR
- 3.6mm fixed lens
- Max. IR LEDs length 20m, Smart IR
- DC12V

## Dimensions(mm)

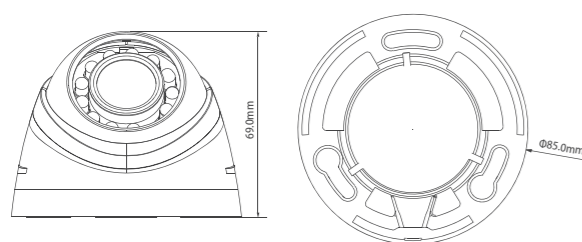

## Accessories (optional)



# HAC-HUM3100/3101B **NEW**



1Megapixel 720P HDCVI Pinhole Camera



## Technical Specifications

Model	HAC-HUM3100BP/N	HAC-HUM3101BP/N
<b>Camera</b>		
Image Sensor	1/2.9" 1Megapixel CMOS	1/3" 1Megapixel CMOS
Effective Pixels	1280(H)×720(V)	
Electronic Shutter	1/50s(60s)~1/100,000s	
Video Frame Rate	25/30fps@720P	
Synchronization	Internal	
Min. Illumination	0.01Lux@F1.2(AGC ON)	
Video Output	1-channel BNC HDCVI high definition video output	1-channel BNC HDCVI high definition video output/ CVBS standard definition video output (Can switch)
<b>Camera Features</b>		
Day/Night	Auto (Electronic) / Color / B/W	
Backlight Compensation	DWDR	WDR (120dB)
Noise Reduction	2D/3D	
OSD Menu	Support	
<b>Lens</b>		
Focal Length	3.6mm	
Angle of View	H: 79.7°	
Mount Type	M12	
<b>General</b>		
Power Supply	DC12V±10%	
Power Consumption	Max 1.5W	Max 2.5W
Working Environment	-30°C~+60°C / Less than 95%RH (no condensation)	
Transmission Distance	Over 800m via 75-3 coaxial cable	
Dimensions(W×D×H)	30mm×30mm×15.9mm	30mm×30mm×21.7mm
Weight	0.05kg	0.06kg
Material	Metal	



## Features

- 1/2.9" 1 Megapixel CMOS (HUM3100B)
- 1/3" 1Megapixel CMOS (HUM3101B)
- 25/30fps@720P
- High speed, long distance real-time transmission
- HD and standard definition switchable
- OSD Menu, control over coaxial cable
- DWDR, Day/Night(ICR), AWB, AGC, BLC, 3D-DNR (HUM3100B)
- WDR(120dB), Day/Night(ICR), AWB, AGC, BLC, 3D-DNR (HUM3101B)
- 3.6mm fixed lens
- DC12V

## Dimensions(mm)

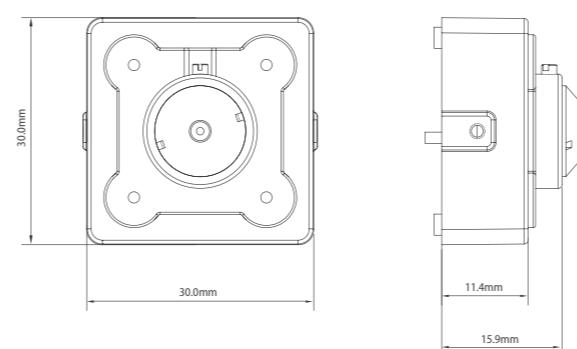

HDCVI DVR

HDCVI Camera

HDCVI PTZ Camera



# DH-HAC-HDBW2220F-M

**NEW**



## 2.4Megapixel 1080P HDCVI Mobile Camera



### Features

- 1/2.8" 2.4Megapixel CMOS
- 25/30@1080P, 25/30/50/60fps@720P
- High speed, long distance real-time transmission
- HD and standard definition switchable
- OSD Menu, control over coaxial cable
- Day/Night(ICR), AWB, AGC, BLC, 3D-DNR
- 3.6mm fixed lens (6mm optional)
- Max. IR LEDs length 20m, Smart IR
- Aviation connector, Shock-proof, Audio
- IP67, IK10, DC12V

### Dimensions(mm)

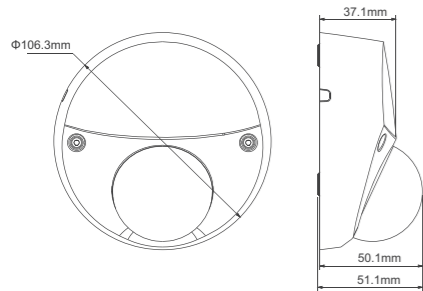

### Accessories (optional)



### Technical Specifications

Model	DH-HAC-HDBW2220FP-M	DH-HAC-HDBW2220FN-M
<b>Camera</b>		
Image Sensor	1/2.8" 2.4Megapixel CMOS	
Effective Pixels	1984(H)×1225(V)	
Electronic Shutter	1/3s~1/100,000s	
Video Frame Rate	25/30/50/60fps@720P; 25/30fps@1080P	
Synchronization	Internal	
Min. Illumination	0.05Lux@F1.2(AGC ON), 0Lux IR on	
Video Output	1-channel BNC HDCVI high definition video output/ CVBS standard definition video output (Can switch)	
<b>Camera Features</b>		
Max. IR LEDs Length	20m, Smart IR	
Day/Night	Auto(ICR) / Color / B/W	
Noise Reduction	2D/3D	
OSD Menu	Support	
<b>Lens</b>		
Focal Length	3.6mm (6mm optional)	
Angle of View	H: 88°(53.4°)	
Mount Type	M12	
<b>General</b>		
Power Supply	DC12V±10%	
Power Consumption	Max 3.3W	
Working Environment	-30°C~+60°C / Less than 95%RH (no condensation)	
Transmission Distance	Over 500m via 75-3 coaxial cable	
Ingress Protection	IP67 & IK10	
Dimensions(W×D×H)	Φ106.3mm×51.1mm	
Weight	0.28kg	
Material	Metal	
Others	With pickup	

# DH-HAC-HDBW2120F-M

**NEW**



## 1.4Megapixel 720P IR HDCVI Mobile Camera



### Features

- 1/3" 1.4Megapixel CMOS
- 25/30/50/60fps@720P
- High speed, long distance real-time transmission
- HD and standard definition switchable
- OSD Menu, control over coaxial cable
- Day/Night(ICR), AWB, AGC, BLC, 3D-DNR
- 3.6mm fixed lens (6mm optional)
- Max. IR LEDs length 20m, Smart IR
- Aviation connector, Shock-proof, Audio
- IP67, IK10, DC12V

### Dimensions(mm)

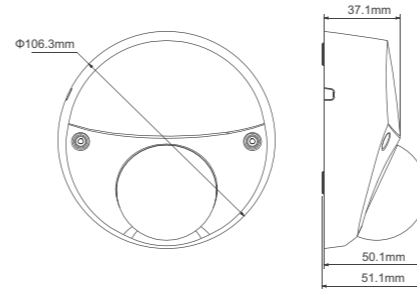

### Accessories (optional)



### Technical Specifications

Model	DH-HAC-HDBW2120FP-M	DH-HAC-HDBW2120FN-M
<b>Camera</b>		
Image Sensor	1/3" 1.4Megapixel CMOS	
Effective Pixels	1305(H)×1049(V)	
Electronic Shutter	1/3s~1/100,000s	
Video Frame Rate	25/50fps@720P	30/60fps@720P
Synchronization	Internal	
Min. Illumination	0.01Lux@F1.2(AGC ON), 0Lux IR on	
Video Output	1-channel BNC HDCVI high definition video output/ CVBS standard definition video output (Can switch)	
<b>Camera Features</b>		
Max. IR LEDs Length	20m, Smart IR	
Day/Night	Auto(ICR) / Color / B/W	
Noise Reduction	2D/3D	
OSD Menu	Support	
<b>Lens</b>		
Focal Length	3.6mm (6mm optional)	
Angle of View	H: 88°(53.4°)	
Mount Type	M12	
<b>General</b>		
Power Supply	DC12V±10%	
Power Consumption	Max 3.2W	
Working Environment	-30°C~+60°C / Less than 95%RH (no condensation)	
Transmission Distance	Over 800m via 75-3 coaxial cable	
Ingress Protection	IP67 & IK10	
Dimensions(W×D×H)	Φ106.3mm×51.1mm	
Weight	0.28kg	
Material	Metal	
Others	With pickup	

# HDCVI PTZ CAMERA



## DH-SD6A220K/230K-HC NEW

### 2Mp 1080P 20x/30x HDCVI IR PTZ Dome Camera



#### Features

- 20x/30x optical zoom
- Max 25/30fps@1080P, 50/60fps@720P resolution
- DWDR, Day/Night(ICR), Ultra DNR, Auto iris, Auto focus
- Control over coaxial cable, long distance real-time transmission
- HD and SD switchable
- Max 240°/s pan speed, 360° endless pan rotation
- Up to 300 presets, 5 auto scan, 8 tour, 5 pattern
- Built-in 2/1 alarm in/out
- Support intelligent 3D positioning with DH-SD protocol
- IR Distance up to 150m
- IP66, OSD

#### Dimensions (mm)

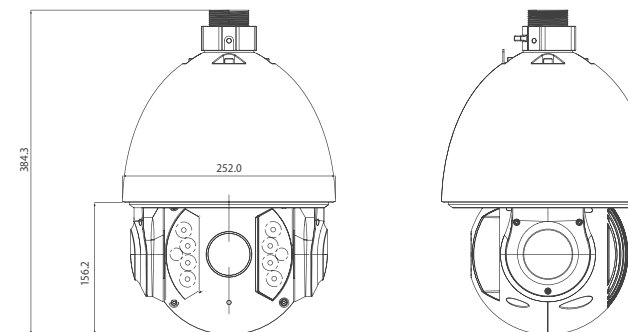

#### Technical Specifications

Model	DH-SD6A220K-HC	DH-SD6A230K-HC
<b>Camera</b>		
Image Sensor	1/2.8" Exmor CMOS	
Effective Pixels	1920(H) x 1080(V)	
Scanning System	Progressive	
Electronic Shutter Speed	1/1 ~ 1/30,000s	
Min. Illumination	Color: 0.05Lux@F1.4; B/W: 0.005Lux@F1.4; 0Lux (IR on)	Color: 0.05Lux@F1.6; B/W: 0.005Lux@F1.6; 0Lux (IR on)
S/N Ratio	More than 55dB	
Resolution	25/30fps@1080P, 25/30/50/60fps@720P	
Video Output	1-channel BNC HDCVI high definition video output/ CVBS standard definition video output (Can switch)	
<b>Camera Features</b>		
Day/Night	Auto(ICR) / Color / B/W	
Backlight Compensation	BLC / HLC / DWDR (Digital WDR)	
White Balance	Auto, ATW, Indoor, Outdoor, Manual	
Gain Control	Auto / Manual	
Noise Reduction	2D/3D	
Privacy Masking	Up to 24 areas	
Digital Zoom	16x	
<b>Lens</b>		
Focal Length	4.7mm~94mm(20x Optical zoom)	4.6mm~138mm(30x Optical zoom)
Max Aperture	F1.4 ~ F2.6	F1.6 ~ F4.8
Focus Control	Auto / Manual	
Angle of View	H: 54.1° ~ 3.2°	H: 60.1° ~ 2.1°
Close Focus Distance	100mm ~ 1000mm	
<b>PTZ</b>		
Pan/Tilt Range	Pan: 0° ~ 360° endless; Tilt: -10° ~ 90°, auto flip 180°	
Manual Control Speed	Pan: 0.1° ~ 200° /s; Tilt: 0.1° ~ 120° /s	
Preset Speed	Pan: 240° /s; Tilt: 200° /s	
Preset	300	
PTZ Mode	5 Pattern, 8 Tour, Auto Pan, Auto Scan	
Speed Setup	Human-oriented focal length/ speed adaptation	
Power up Action	Auto restore to previous PTZ and lens status after power failure	
Idle Motion	Activate Preset/ Scan/ Tour/ Pattern if there is no command in the specified period	
Protocol	DH-SD, Pelco-P/D (Auto recognition)	
IR Distance	150m	
<b>Audio</b>		
Interface	1 channel In	
<b>Auxiliary Interface</b>		
RS485	1	
Alarm	2/1 channel In/Out	
<b>General</b>		
Power Supply	AC 24V/3A (±10%)	
Power Consumption	15.2W, 38.2W (IR on, Heater on)	
Working Environment	-40°C ~ 70°C / Less than 90% RH	
Ingress Protection	IP66	
Vandal Resistance	N/A	
Dimensions	Φ252mm×384.3mm	
Weight	6.75kg	

#### Accessories



#### Accessories(optional)





# DH-SD50(52C)220K/230K-HC NEW

2Mp Full HD 20x/30x Ultra-high Speed HDCVI PTZ Dome Camera

## Technical Specifications



### Features

- 20x/30x optical zoom
- Max 20/30fps@1080P, 50/60fps@720P resolution
- DWDR, Day/Night(ICR), Ultra DNR, Auto iris, Auto focus
- Max 500°/s pan speed, 360° endless pan rotation
- Control over coaxial cable, long distance real-time transmission
- HD and SD switchable
- Up to 300 presets, 5 auto scan, 8 tour, 5 pattern
- Built-in 2/1 alarm in/out
- Support intelligent 3D positioning with DH-SD protocol
- IP67(outdoor), IK10

### Dimensions (mm)

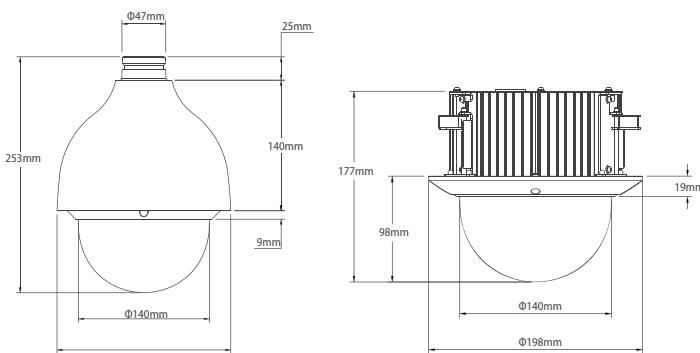

### Accessories



### Accessories(optional)



# DH-SD40/42/42C212K-HC

2Mp Mini HDCVI PTZ Dome Camera

## Technical Specifications



### Features

- Powerful 12x optical zoom
- Max. 25/30fps@1080P, 50/60fps@720P resolution
- DWDR, Day/Night (ICR), Ultra DNR, Auto iris, Auto focus, AWB, AGC, BLC
- HD and SD switchable
- Max 300°/s pan speed, 360° continuous pan rotation
- Control over coaxial cable, long distance real-time transmission
- Up to 300 presets, 5 auto scan, 8 tour, 5 pattern
- Built-in 2/1 alarm in/out
- Support intelligent 3D positioning with DH-SD protocol
- IP66(outdoor), IK10, OSD

### Dimensions (mm)

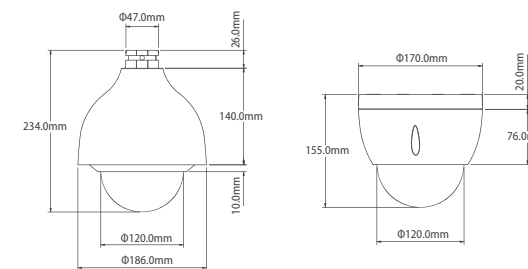

### Accessories-SD40212K-HC



### Accessories(Optional)-SD40212K-HC



Model	DH-SD40212K-HC	DH-SD42212K-HC	DH-SD42C212K-HC
<b>Camera</b>			
Image Sensor	1/2.8" Exmor CMOS		
Effective Pixels	1944(H)×1092(V), 2 Megapixels		
Horizontal Resolution	≥1000TVL		
Scanning System	Progressive		
Electronic Shutter Speed	1/1 ~ 1/30,000s		
Min. Illumination	Color: 0.05Lux@F1.6, B/W: 0.005Lux@F1.6		
S/N Ratio	More than 50dB		
Resolution	25/30fps@1080P, 25/30/50/60fps@720P		
Video Output	1-channel BNC HDCVI high definition video output/ CVBS standard definition video output (Can switch)		
<b>Camera Features</b>			
Day/Night	Auto(ICR) / Color / B/W		
Backlight Compensation	BLC / HLC / DWDR (Digital WDR)		
White Balance	Auto, ATW, Indoor, Outdoor, Manual		
Gain Control	Auto / Manual		
Noise Reduction	2D/3D		
Privacy Masking	Up to 24 areas		
Digital Zoom	16x		
<b>Lens</b>			
Focal Length	5.1 mm~61.2mm (12x Optical zoom)		
Max Aperture	F1.6~ F3.0		
Focus Control	Auto / Manual		
Angle of View	H:51.3° ~ 4.64°		
Close Focus Distance	100mm~1000mm		
<b>PTZ</b>			
Pan/Tilt Range	Pan: 0° ~ 360° endless; Tilt: -2° ~ 90°, auto flip 180°		
Manual Control Speed	Pan: 0.1° ~ 300°/s; Tilt: 0.1° ~ 120°/s		
Preset Speed	Pan: 300°/s; Tilt: 200°/s		
Preset	300		
PTZ Mode	5 Pattern, 8 Tour, 5 Auto Scan, Auto Pan		
Speed Setup	Human-oriented focal length/ speed adaptation		
Power up Action	Auto restore to previous PTZ and lens status after power failure		
Idle Motion	Activate Preset/ Scan/ Tour/ Pattern if there is no command in the specified period		
Protocol	DH-SD, Pelco-P/D (Auto recognition)		
<b>Audio</b>			
Interface	1 channel In		
<b>Auxiliary Interface</b>			
RS485	1		
Alarm	2/1 channel In/Out		
<b>General</b>			
Power Supply	AC24V/1.5A (±10%)		
Power Consumption	10W, 19W(Heater on)		10W
Working Environment	-40°C ~ 60°C / Less than 90% RH		-20°C ~ 60°C / Less than 90% RH
Ingress Protection	IP66		N/A
Vandal Resistance	IK10		
Dimensions	Outdoor: Φ186.0mm×253mm	Φ170mm×155mm	Φ198mm×158mm
Weight	Outdoor: 2.5kg	1.8kg	2.0kg

### Accessories(Optional)-SD42212K-HC



# DH-SD22204K-GC NEW

## 2Mp HDCVI Mini PTZ Dome Camera



### Features

- Powerful 4x optical zoom
- Max. 25/30fps@1080P, 50/60fps@720P resolution
- DWDR, Day/Night (ICR), Ultra DNR, Auto iris, Auto focus, AWB, AGC, BLC
- Max 100°/s pan speed
- Control over coaxial cable, long distance real-time transmission
- HD and SD switchable
- Up to 300 presets, 5 auto scan, 8 tour, 5 pattern
- Support intelligent 3D positioning with DH-SD protocol
- IP66, IK10, OSD

### Dimensions (mm)

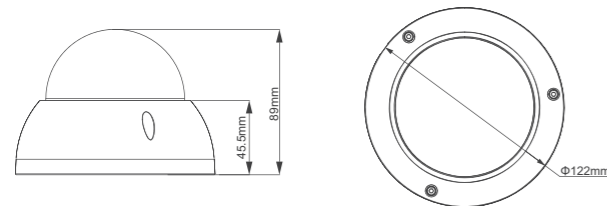

### Accessories(Optional)



### Technical Specifications

Model	DH-SD22204K-HC
<b>Camera</b>	
Image Sensor	1/2.7" Exmor CMOS
Effective Pixels	1944(H) x 1092(V), 2 Megapixels
Horizontal Resolution	≥1000TVL
Scanning System	Progressive
Electronic Shutter Speed	1/1s ~ 1/30,000s
Min. Illumination	Color: 0.05 Lux/F1.6, B/W: 0.005Lux/F1.6
S/N Ratio	More than 55dB
Resolution	25/30fps@1080P, 25/30/50/60fps@720P
Video Output	1-channel BNC HDCVI high definition video output/ CVBS standard definition video output (Can switch)
<b>Camera Features</b>	
Day/Night	Auto(ICR) / Color / B/W
Backlight Compensation	BLC / HLC / DWDR (Digital WDR)
White Balance	Auto, ATW, Indoor, Outdoor, Manual
Gain Control	Auto / Manual
Noise Reduction	2D / 3D
Privacy Masking	Up to 24 areas
Digital Zoom	16x
<b>Lens</b>	
Focal Length	2.7 mm~11mm (4x Optical zoom)
Max Aperture	F1.6~ F2.8
Focus Control	Auto / Manual
Angle of View	H: 116.5° ~ 34.5°
Close Focus Distance	100mm~1000mm
<b>PTZ</b>	
Pan/Tilt Range	Pan: 0° ~ 355° ; Tilt: 0° ~ 90°, auto flip 180°
Manual Control Speed	Pan: 0.1° ~ 100°/s; Tilt: 0.1° ~ 60°/s
Preset Speed	Pan: 100°/s; Tilt: 60°/s
Preset	300
PTZ Mode	5 Pattern, 8 Tour, 5 Auto Scan, Auto Pan
Speed Setup	Human-oriented focal length/ speed adaptation
Power up Action	Auto restore to previous PTZ and lens status after power failure
Idle Motion	Activate Preset/ Scan/ Tour/ Pattern if there is no command in the specified period
Protocol	DH-SD, Pelco-P/D (Auto recognition)
<b>Auxiliary Interface</b>	
RS485	1
<b>General</b>	
Power Supply	DC12V
Power Consumption	10W
Working Environment	-20°C ~ 60°C / Less than 90% RH
Ingress Protection	IP66
Vandal Resistance	IK10
Dimensions	Φ122mm×89mm
Weight	0.95kg

# DH-SD6A120K-HC NEW

## 720P 20x HDCVI IR PTZ Dome Camera



### Features

- 20x optical zoom
- Max 50/60fps@720P resolution
- DWDR, Day/Night(ICR), Ultra DNR, Auto iris, Auto focus
- Control over coaxial cable, long distance real-time transmission
- HD and SD switchable
- Max 240°/s pan speed, 360° endless pan rotation
- Up to 300 presets, 5 auto scan, 8 tour, 5 pattern
- Built-in 2/1 alarm in/out
- Support intelligent 3D positioning with DH-SD protocol
- IR Distance up to 150m
- IP66, OSD

### Dimensions (mm)

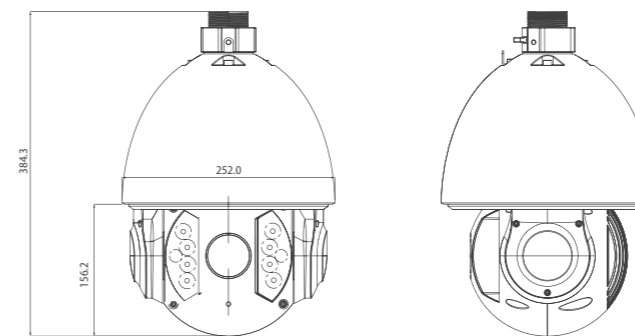

### Accessories



### Accessories(optional)



### Technical Specifications

Model	DH-SD6A120K-HC
<b>Camera</b>	
Image Sensor	1/3" Exmor CMOS
Effective Pixels	1280(H)×960(V)
Scanning System	Progressive
Electronic Shutter Speed	1/1 ~ 1/30,000s
Min. Illumination	Color: 0.05Lux@F1.4; B/W: 0.005Lux@F1.4; 0Lux (IR on)
S/N Ratio	More than 55dB
Resolution	25/30/50/60fps@720P
Video Output	1-channel BNC HDCVI high definition video output/ CVBS standard definition video output (Can switch)
<b>Camera Features</b>	
Day/Night	Auto(ICR) / Color / B/W
Backlight Compensation	BLC / HLC / DWDR (Digital WDR)
White Balance	Auto, ATW, Indoor, Outdoor, Manual
Gain Control	Auto / Manual
Noise Reduction	2D / 3D
Privacy Masking	Up to 24 areas
Digital Zoom	16x
<b>Lens</b>	
Focal Length	4.7mm~94mm (20x Optical zoom)
Max Aperture	F1.4~F2.6
Focus Control	Auto / Manual
Angle of View	H: 54.1° ~ 3.2°
Close Focus Distance	100mm~1000mm
<b>PTZ</b>	
Pan/Tilt Range	Pan: 0° ~ 360° endless; Tilt: -10° ~ 90°, auto flip 180°
Manual Control Speed	Pan: 0.1° ~ 200° /s; Tilt: 0.1° ~ 120° /s
Preset Speed	Pan: 240° /s; Tilt: 200° /s
Preset	300
PTZ Mode	5 Pattern, 8 Tour, Auto Pan, Auto Scan
Speed Setup	Human-oriented focal length/ speed adaptation
Power up Action	Auto restore to previous PTZ and lens status after power failure
Idle Motion	Activate Preset/ Scan/ Tour/ Pattern if there is no command in the specified period
Protocol	DH-SD, Pelco-P/D (Auto recognition)
IR Distance	150m
<b>Audio</b>	
Interface	1 channel In
<b>Auxiliary Interface</b>	
RS485	1
Alarm	2/1 channel In/Out
<b>General</b>	
Power Supply	AC 24V/3A (±10%)
Power Consumption	15.2W, 38.2W (IR on, Heater on)
Working Environment	-40°C ~ 70°C / Less than 90% RH
Ingress Protection	IP66
Vandal Resistance	N/A
Dimensions	Φ252(mm) × 384.3 (mm)
Weight	6.75kg



